

# ***AN-6100C***

## ***INSTALLATION AND CONFIGURATION MANUAL***

Publication 1084-852  
Rev. B  
08 March 2004

**AMETEK POWER Instruments**  
255 N. Union Street  
Rochester, New York 14605

Tel: (800) 881-4156  
Fax: (585) 238-4945  
Web: [www.ametekpower.com](http://www.ametekpower.com)



# *Please Read This First!*

## **Explanation of Symbols**

The following symbols are used with this product and instruction manual for compliance with UL 61010B-1, Electrical Measuring and Test Equipment.



**Caution** (refer to the product instruction manual for installation and safety information)

## **IMPORTANT NOTES**

**THE ANNUNCIATOR DESCRIBED IN THIS MANUAL REQUIRES A 24V DC POWER SOURCE. THIS MAY BE DERIVED FROM A REMOTE HIGH VOLTAGE AC OR DC POWER SUPPLY UNIT. THE FIELD CONTACT VOLTAGE MAY BE SELECTED FOR 24/48/125V DC OR 120V AC**

\*\*\*\*\*

**ENSURE THAT ALL INSTALLTION/TESTING AND COMMISIONING IS CARRIED OUT BY TRAINED AND QUALIFIED PERSONNEL TAKING ANY RELEVANT PRECAUTIONS CONCERNING HAZARDOUS VOLTAGES**

\*\*\*\*\*

**UNAUTHORISED MODIFICATIONS OR REPAIRS WILL INVALIDATE THE AMETEK WARRANTY PLEASE CONTACT THE AMETEK CUSTOMER SERVICES DEPARTMENT BEFORE TAKING SUCH ACTIONS**

\*\*\*\*\*

**STANDARD DEFAULT SETTINGS ARE INDICATED IN THIS MANUAL TO WHICH AN-6100C ANNUNCIATORS WILL BE SET SHOULD NO SPECIFIC CONFIGURATION OR SET UP DETAILS BE SUPPLIED WITH PURCHASE ORDERS**

<b>REVISION HISTORY</b>				
<b>Revision</b>	<b>Date</b>	<b>Description</b>	<b>Author</b>	<b>Approved</b>
01	18feb03	AN-6100C Installation and Configuration Manual	MJF	
02	4apr03	Updated per UL requirements Added configurator information	S. Adam	
04	24feb04	Updated Appendix A	MJF	
05	08mar04	Updated Relay Output Mode & F3A tables per API-ECO-11626 / CAR169	SB	

# Table of Contents

<b>INTRODUCTION .....</b>	<b>3</b>
CONSTRUCTION.....	3
DISPLAY.....	4
ANNUNCIATOR MODEL CODE DEFINITION.....	5
<b>HARDWARE SPECIFICATION .....</b>	<b>7</b>
FIELD INPUTS .....	7
<i>DC Input Card</i> .....	7
<i>Isolated Input Card</i> .....	8
<i>Input Response Times</i> .....	8
OUTPUTS.....	8
<i>Individual Relays</i> .....	8
<i>Audible</i> .....	8
<i>Common Services Module (CSM) Relays</i> .....	9
DISPLAY WINDOWS.....	10
COMMUNICATIONS.....	10
<b>ENVIRONMENTAL SPECIFICATION .....</b>	<b>11</b>
TEMPERATURE .....	11
HUMIDITY .....	11
RADIATED RFI IMMUNITY .....	11
CONDUCTED RFI IMMUNITY .....	11
RADIATED EMISSIONS .....	11
CONDUCTED EMISSIONS.....	11
RADIATED POWER FREQUENCY MAGNETIC FIELD .....	11
ESD EFFECTS.....	11
DIELECTRIC WITHSTAND .....	12
SURGE WITHSTAND – OSCILLATORY .....	12
ELECTRICAL FAST TRANSIENT/BURST IMMUNITY.....	12
SURGE IMMUNITY .....	12
APPROVALS.....	12
<b>INSTALLATION.....</b>	<b>13</b>
MOUNTING.....	13
WIRING .....	15
<b>INPUT HARDWARE CONFIGURATION.....</b>	<b>21</b>
FIELD CONTACT VOLTAGE (FCV).....	21
INPUT CARD LINKS AND SWITCHES .....	22
<i>FCV selection</i> .....	22
<i>Input Contact Selection</i> .....	22
<i>Relay Output Mode Selection</i> .....	23
CSM CARD LINKS.....	23
<i>Relay Output Mode Selection</i> .....	23
<i>Serial Comms Selection</i> .....	24
<i>Serial Comms Connection</i> .....	24
<b>POWER SUPPLY.....</b>	<b>25</b>
<i>Connecting Power</i> .....	25
POWER REQUIREMENTS .....	25
<b>AVAILABLE SEQUENCES .....</b>	<b>27</b>

<b>CONFIGURATION .....</b>	<b>31</b>
INTRODUCTION .....	31
SOFTWARE INSTALLATION .....	31
SOFTWARE CONFIGURATION INSTRUCTIONS .....	32
<b>MENUS.....</b>	<b>33</b>
<i>Main menu overview</i> .....	33
FILE .....	34
<i>New</i> .....	34
<i>Open</i> .....	34
<i>Save</i> .....	35
<i>Save As</i> .....	35
<i>Create Duplicate</i> .....	35
<i>Print</i> .....	35
<i>Print Setup</i> .....	35
<i>Start Wizard</i> .....	35
<i>Recent Files</i> .....	35
OPTIONS.....	36
<i>Preferences</i> .....	36
<i>View Configuration (Text)</i> .....	37
<i>Upgrade</i> .....	38
CONNECTIONS.....	39
<i>Configuration</i> .....	39
<i>Communication Settings</i> .....	40
CONFIGURATION MISMATCH .....	41
SERIAL ID MISMATCH.....	42
CONFIGURATION WIZARD.....	43
<i>System</i> .....	43
<i>Input Configuration</i> .....	45
<i>Lamp Settings</i> .....	49
<i>Group Settings</i> .....	50
<i>Common Service Module (CSM)</i> .....	51
<i>Modbus</i> .....	54
<i>Quick Access</i> .....	57
<b>SERVICING .....</b>	<b>59</b>
MODULE REMOVAL .....	59
<b>APPENDIX A .....</b>	<b>61</b>
MODBUS DATA FORMATS .....	61
<i>Alarm State Mode</i> .....	62
<i>Point Mode</i> .....	63
<i>AN3135 Mode</i> .....	63
<i>Modbus Addresses</i> .....	64
<i>Default Values</i> .....	64
<b>APPENDIX B.....</b>	<b>65</b>
<b>APPENDIX C .....</b>	<b>71</b>
TELEPHONE / FAX NUMBER LIST .....	71
PROCEDURES FOR FACTORY REPAIR AND RETURN .....	72
WARRANTY .....	72

## Scope

This manual describes the installation and configuration of the AN-6100C annunciator system. This includes operation of its associated configuration software.

## Glossary of Terms

FCV:	Field contact or wetting voltage for alarm inputs.
CSM:	Common service module housing common alarm controls and output relays. Located at the bottom right of the front panel.
ACK:	Acknowledge. Operator alarm control.
RST:	Reset. Operator alarm control.
SIL:	Silence. Clears the alarm horn.
TEST:	Performs one of a selection of system tests.
First Out:	First alarm within a designated group to occur, typically with a distinctive lamp flash pattern from the others.
Alarm Group:	A designated group of alarm inputs all operating a common sequence of lamp operation (flash states)
Relay Group:	A designated group of alarm inputs operating a common output or repeat relay.





# INTRODUCTION

## CONSTRUCTION

The AN-6100C is constructed from display modules 130mm wide by 58mm high (5.12 by 2.28 inches). A system is built up from a matrix of modules or cells up to 5 high by 5 wide. The cells can be configured for 1, 2, 4 or 8 windows per display module allowing a range of system sizes from 1 to 196 alarm points in one system.

Each cell is made up from a moulding with rear mounted electronics. These mouldings fix together to form the required matrix, which is then clamped together on all sides by a combined fixing bracket and bezel. I/O cards are accessed and inserted from the rear. All power and field connections are via pluggable screw terminals. Protective screw fitted rear cover panels are provided. Serial (Modbus™) connection is via a 9 way D-type connector.

## DISPLAY

The moulding for each display module is divided into four sections, corresponding to medium size windows (4 per module). By inserting a divider small size windows are created. Snap off sections on each module allow for the creation of the larger window sizes.

A push on lens assembly, containing the printed film legend, is fitted onto the front of each moulding.

The lens assembly for the common services module is always located in the bottom right hand position of the chassis (viewed from the front), and includes the TEST, SILENCE (SIL), ACKNOWLEDGE (ACK), and RESET control pushbuttons.

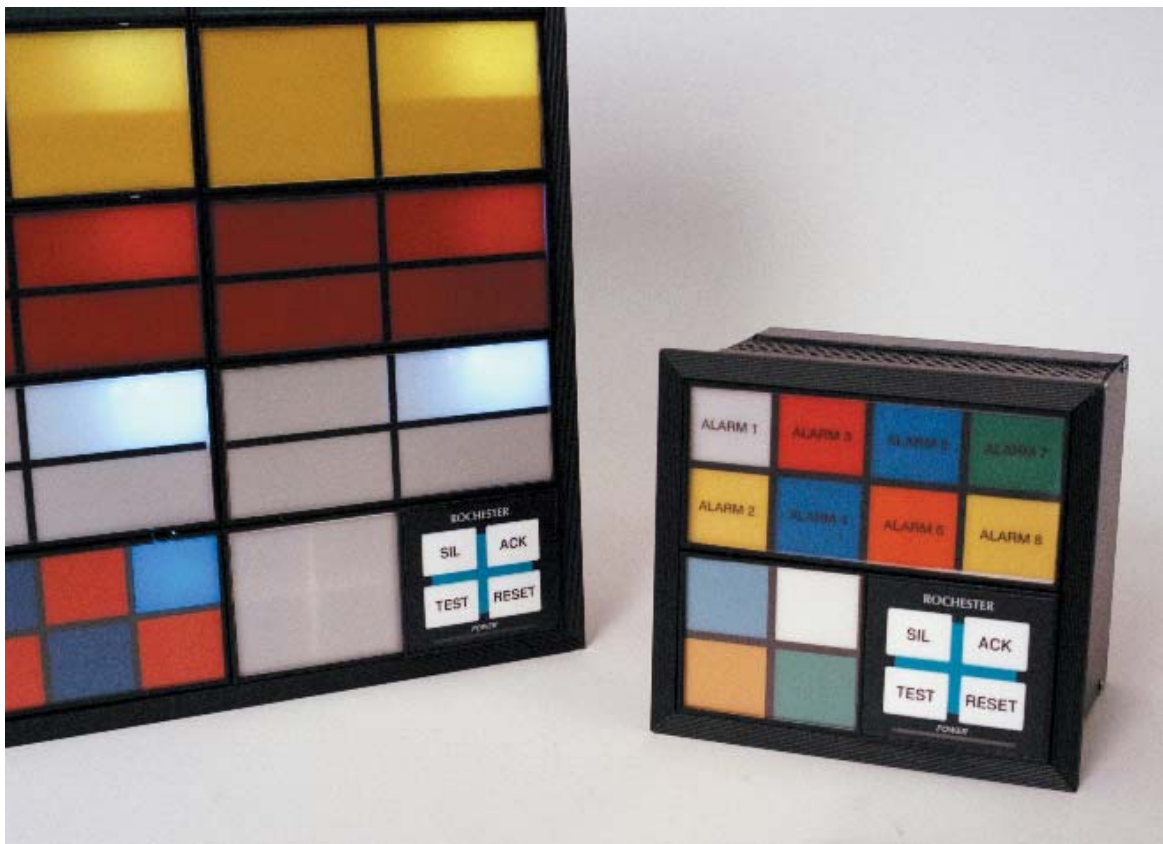

Alarm Fascia Views

# ANNUNCIATOR MODEL CODE DEFINITION

The AN-6100C model code is defined below.

Code		System Size	
AN6100C - X - Y		X= Number of Cells High	Y= Number of Cells Wide

Code		Pushbutton Controls	
INT	Integral pushbuttons located in bottom right cell	(Connections provided for External Pushbuttons)	
NPB	No Integral pushbuttons	(Pushbuttons replaced with a blank plate)	

Code		Window Size	
S	Small Window, 8 per cell	(0.98" x 1.14")	
M	Medium Window, 4 per cell	(0.98' x 2.40')	
L	Large Window, 2 per cell	(2.13' x 2.40')	[expandable to 4 per cell]
EL	Extra Large Window, 1 per cell	(2.13' x 4.96')	[expandable to 4 per cell]
IMW	Intermix Window size, matrix must be included		

Code		Active Points	
		Total # of Active Points (see cell matrix)	

Code		Window Color	
W	White Window		
R	Red Window		
A	Amber Window		
G	Green Window		
B	Blue Window		
Y	Yellow Window		
IMC	Intermix color, matrix must be included	(Note: This can be field changeable by the customer)	

Code		Operational Sequence	
		A; A4; A456; M; R; R-12; F1A; F3A; F2M-1; FFAM2; F3C, R12C	
IMO	Intermixed sequences - supply a configuration matrix	(Can be field configured by customer)	

Code		Field Contact Status	
N/O	Normally Open Contacts (standard)		
N/C	Normally Closed Contacts		
IMI	Intermixed Open and Closed, supply matrix	(Can be field configured by customer)	

Code		Field Contact Voltage (FCV)	
		Field Contact Voltage supplied by Rochester; with common system-wide FCV return	
F24	24VDC	Internally Supplied by RIS	
		Field Contact Voltage externally supplied by Customer; with common system-wide return	
F5C	5VDC	Externally Supplied by Customer	
F24C	24VDC	Externally Supplied by Customer	
F240C	24VDC	Externally Supplied by Customer	
F48C	48VDC	Externally Supplied by Customer	
F125C	125VDC	Externally Supplied by Customer	
F120C	120VAC/ 125VDC (isolated per point)	Externally Supplied by Customer	
SI	Serial Modbus Input Only (repeat relays not available)		

Code	Number of Repeat Relays																										
	___	Total number of repeat relays																									
Code	Repeat Relay Type																										
FOE	Follows field contact, N.O. contacts, coil energized																										
FOD	Follows field contact, N.O. contacts, coil de-energized																										
FCE	Follows field contact, N.C. contacts, coil energized																										
FCD	Follows field contact, N.C. contacts, coil de-energized																										
MOE	Follows alarm memory, N.O. contacts, coil energized																										
MOD	Follows alarm memory, NO contacts, coil de-energized																										
MCE	Follows alarm memory, NC contacts, coil energized																										
MCD	Follows alarm memory, NC contacts, coil de-energized																										
IMR	Intermix Relay (must include matrix) (Can be field configured by customer)																										
NR	No Repeat Relays required																										
Code	Power Source																										
A	24VDC																										
C1	48VDC (36-72 VDC)																										
C2	125VDC (72-144 VDC)																										
C3	250VDC (90-300 VDC)																										
CB1	AC/DC (100-240 VAC or 90-300 VDC)																										
B1	120VAC, 60HZ (88-264 VAC, 50/60 Hz)																										
B2	230VAC, 50HZ (88-264 VAC, 50/60 Hz)																										
Code	Mounting Style																										
FP	Flush Panel Mounting																										
STD/1	19" Rack Mounting for 1 high x 3 Wide Annunciators																										
STD/2	19" Rack Mounting for 2 high x 3 Wide Annunciators																										
STD/3	19" Rack Mounting for 3 high x 3 Wide Annunciators																										
STD/4	19" Rack Mounting for 4 high x 3 Wide Annunciators																										
STD/5	19" Rack Mounting for 5 high x 3 Wide Annunciators																										
Code	Legend Style																										
LP	Legends are Laser Printed on transparency film																										
LPH	Legends are Hidden till Lit																										
ENG	Legends are engraved on Windows																										
<b>Note:</b> Legend information must be provided to AMETEK 1 week prior to delivery																											
Code	Protective Coating																										
CC	Protective Coating																										
NR	Not Required																										
Code	Modbus Communications																										
MB	Bi-Directional Serial Modbus																										
NR	Not Required																										
<table border="1" style="width: 100%; border-collapse: collapse; text-align: center;"> <tr> <td style="width: 10%;">AN6100C-2H-4W</td> <td style="width: 5%;">INT</td> <td style="width: 5%;">S</td> <td style="width: 5%;">60</td> <td style="width: 5%;">W</td> <td style="width: 5%;">A</td> <td style="width: 5%;">N/O</td> <td style="width: 5%;">F24</td> <td style="width: 5%;">NR</td> <td style="width: 5%;">NR</td> <td style="width: 5%;">B1</td> <td style="width: 5%;">FP</td> <td style="width: 5%;">LP</td> <td style="width: 5%;">NR</td> <td style="width: 5%;">MB</td> <td style="width: 10%;">&lt;-- (Typical Model Number)</td> </tr> </table>												AN6100C-2H-4W	INT	S	60	W	A	N/O	F24	NR	NR	B1	FP	LP	NR	MB	<-- (Typical Model Number)
AN6100C-2H-4W	INT	S	60	W	A	N/O	F24	NR	NR	B1	FP	LP	NR	MB	<-- (Typical Model Number)												

# HARDWARE SPECIFICATION

## FIELD INPUTS

There shall be up to 1, 2, 4 or 8 inputs per cell. Each input card can support up to 4 inputs. Two cards are required for 8 inputs.

### *DC Input Card*

The inputs are jumper configurable for the following nominal input levels and types.

24 VDC Contact  
48 VDC Contact  
125 VDC Contact  
5 VDC Logic  
24 VDC open collector

Input current at nominal:	1.6mA per input.
Maximum input voltage without damage:	50% over nominal.
Input loop resistance:	200K minimum resistance across open contacts. 2K maximum series resistance.
Input isolation:	All inputs are opto-isolated. Inputs are not isolated from each other.

Each input is configurable via switch on the input card for normally closed contact (open to alarm) or normally open contact (close to alarm).

There is a system connection provided for FCV and input common at the rear CSM terminals. The 24VDC Annunciator power input may be connected to the FCV terminals. (**Note:** Using the 24VDC Power Input will defeat the 500VAC input to power isolation.) Otherwise the user may provide a separate FCV supply. The FCV Input terminals at the rear of the CSM are internally bussed to all FCV terminals on each input card.

## ***Isolated Input Card***

Input voltage:	120VAC/125VDC nominal
Input current at nominal:	1.2mA
Maximum input voltage without damage:	50% over nominal
Input isolation:	All inputs are opto-isolated. Inputs are isolated from each other at 250Vac.

Each input is configurable via switch on the input card for normally closed contact (open to alarm) or normally open contact (close to alarm).

## ***Input Response Times***

Default response: (input delay or deadband, alarm on and off)	40mS
Software input delay: (alarm on only) (in units of 50mS or 1S, system wide configurable)	0-255 time units
First Out Discrimination	5mS

## **OUTPUTS**

### ***Individual Relays***

Repeat relays may be optionally provided for each input. Relays are a SPDT with jumpers provided for either a N.O (Form A) or N.C. (Form B) connection.

Contact type:	N.O. or N.C. (link selectable)
Contact rating:	30 Vdc @ 2 amps 30 Vdc @ 1 amp for UL listed 110 Vdc @ 0.3 amps 120 Vac 0.5 amps

The available modes of contact operation are described in the Software Configuration section.

### ***Audible***

Internal low level (80dB) audible within the Common Service Module (CSM) configurable via software. The internal audible device responds to any alarm whether it is designated as critical or non-critical. External audible devices can be connected to the CSM relays as detailed below.

## ***Common Services Module (CSM) Relays***

Four configurable relays are available in the CSM. Relays are a SPDT with jumpers provided for either a N.O (Form A) or N.C. (Form B) connection.

Contact type:	N.O. or N.C. (link selectable)
Contact rating:	30 Vdc @ 2 amps
	30 Vdc @ 1 amp for UL listed
	110 Vdc @ 0.3 amps
	120 Vac 0.5 amps

The available modes of contact operation are described in the Software Configuration section.

## DISPLAY WINDOWS

Each Display Module or Cell can accommodate any of the four windows sizes shown below.

### *Window Sizes (nominal)*

Small (8 per cell):	25 x 30mm
Medium (4 per cell):	25 x 60mm
Large (2 per cell):	55 x 60mm
Extra Large (1 per cell):	55 x 125mm

Extra Large (1 input per cell) and Large Windows (2 inputs per cell) have future expansion built in, as the I/O cards support 4 inputs. To enable the extra inputs, you simply convert the window from the original size to one smaller (Ex: Large to Medium). To convert the window size, you need to print new window legends per below, connect your extra inputs and re-configure the unit for your new window size.

### *Window Colors*

Window Colors are provided through factory supplied colored filters. Window colors may also be printed on the clear transparency film used for the Legends. (Typically done with intermixed window colors). A window size template is provided on the same CD with the Configuration Software. Using the Template, you pick your window size and fill in the color required. When finished, load the transparency film in your color Printer and print. The standard colors available are: white, red, yellow, amber, green and blue

### *Legends*

Window Legends are printed on the same clear transparency film as the window colors shown above. The Window Template lets you choose any font type that fits in the space provided. This allows easy changes at any time. As an option, the window legends may be engraved at the factory using a black or white fill.

**Note:** If specified at time of order, window colors and legends will be provided by the factory.

## COMMUNICATIONS

Serial communication are through a 9-pin female D-type connector on the CSM. The interface is jumper selectable for either RS-232 or RS-485.

The interface is configurable for Modbus™ RTU or ASCII protocols. It also supports the native AN-6100C configuration protocol. This is accessed only using the AMETEK Configuration Software.



# ENVIRONMENTAL SPECIFICATION

## TEMPERATURE

Operating Temperature Range: -20 to 50 °C  
Storage Temperature Range: -20 to 80 °C

## HUMIDITY

Operate over 20 to 95% RH

## RADIATED RFI IMMUNITY

IEC 61000-4-3 10 V/m

## CONDUCTED RFI IMMUNITY

IEC 61000-4-6 3V

## RADIATED EMISSIONS

IEC 61326-1/04.97 +A1:1998 Class B  
IEC 61000-6-3.

## CONDUCTED EMISSIONS

IEC 61326-1/04.97 +A1:1998 Class B  
IEC 61000-6-3.

## RADIATED POWER FREQUENCY MAGNETIC FIELD

IEC 61000-4-8 30 A/m

## ESD EFFECTS

IEC 61000-4-2 4kV contact 8kV air

## **DIELECTRIC WITHSTAND**

All voltages are 60Hz for 1 minute

1150 V dc / 820 V RMS from Inputs to Outputs  
1150 V dc / 820 V RMS from Outputs to Power  
1150 V dc / 820 V RMS from Inputs to Case  
1150 V dc / 820 V RMS from Outputs to Case  
1150 V dc / 820 V RMS from Inputs to Communication port  
1150 V dc / 820 V RMS from Outputs to Communication port  
500 V RMS from Output to Output  
500 V RMS from Inputs to Power  
500 V RMS from Communications Ports to Case

250 V RMS input to input on the Isolated Inputs Card  
Inputs on the DC Input Card are not isolated from each other

## **SURGE WITHSTAND – OSCILLATORY**

Oscillatory portion of ANSI C37.90.1

## **ELECTRICAL FAST TRANSIENT/BURST IMMUNITY**

IEC 61000-4-4	2kV	DC power
	1kV	I/O

## **SURGE IMMUNITY**

IEC 61000-4-5	1kV	Common Mode (line-to-ground)
---------------	-----	------------------------------

## **APPROVALS**

UL Recognized for Category 2, Pollution Degree 2, up to 2000 meters, indoor use  
ULC (UL Canada)  
CE

# INSTALLATION

## MOUNTING

The system is designed for panel mounting. The dimensions given in the tables below refer to the size of the panel cut out required for mounting and the front bezel height and width. The height and width are related to the number of cells in the system. See Appendix B.

	Number of Cells High				
	1	2	3	4	5
<b>Bezel Height</b>	2.99 (76)	5.29 (134)	7.59 (193)	9.89 (251)	12.19 (310)
<b>Cut-out Height</b>	2.66 (68)	4.96 (126)	7.26 (184)	9.56 (243)	11.86 (301)

	Number of Cells Wide				
	1	2	3	4	5
<b>Bezel Width</b>	5.83 (148)	10.98 (279)	16.13 (410)	21.28 (541)	26.43 (671)
<b>Cut-out Width</b>	5.50 (140)	10.65 (270)	15.80 (401)	20.95 (532)	26.1 (663)

**Note 1:** Dimensions shown are in inches (mm)

**Note 2:** Tolerance on all cut out dimensions is 0.625 inches (1.5mm)

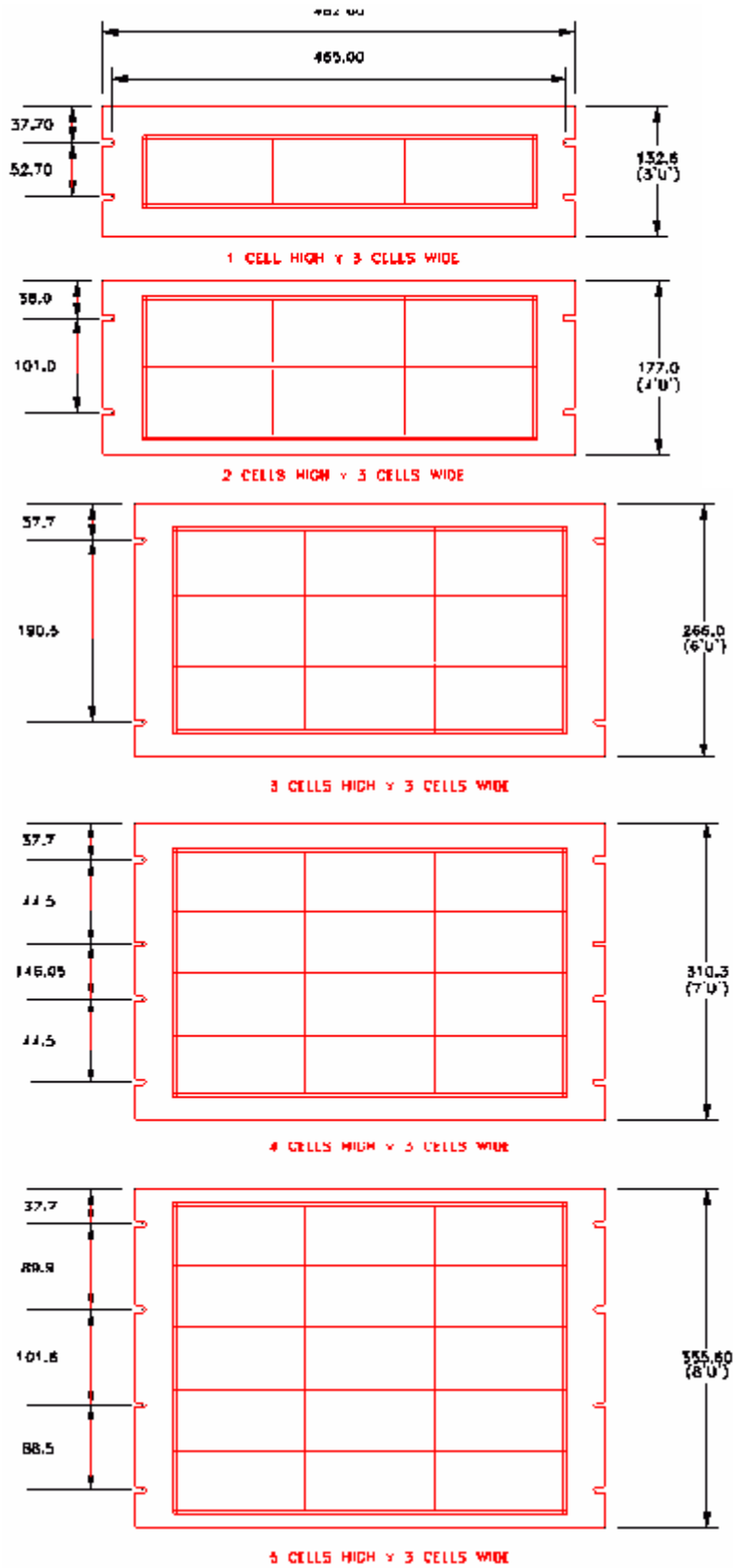

## 19 Inch Rack Mounting Panels (dimensions in mm)

Depths	mm	Inches
Mounting panel to rear panel	99	3.9
Mounting panel to terminals	117	4.61
Front bezel to terminals	122	4.8
It is suggested that 100mm (4 inches) be left behind the rear terminals to allow for cable marshalling. This will depend on the cable type and site circumstances		

Minimum mounting panel thickness: 18 GA Galvanneal, 0.072 inches, 1.83 mm.

For system installation perform the following steps:

- 1 Mark cut-out dimensions on the surface where the annunciator is to be mounted, keeping in mind that the assembly may rest on the sill of the cut-out.  
**NOTE:** Allow a minimum of 6 inches (150 mm) above the unit, behind the panel, for proper ventilation.
- 2 Cut out and remove panel material.
- 3 Temporally remove the panel mounting clamps and Install the annunciator assembly through the panel cut-out (from the front of the panel). Position within the cut-out so that the weight is taken at the bottom of the unit.
- 4 From the rear of the panel, replace the annunciator mounting clamps along the bottom then top and sides screws to “finger tight” check the front of panel alignment on panel face etc and fully tighten the mounting clamps.

## WIRING

For ease of wiring and maintenance the AN-6100C series uses a Eurostyle 2 part plug and header system with industry standard scalloped design. These offer the convenience of plugability and the superior reliability of rising cage pressure clamps for secure wiring. Each terminal accepts a maximum wire size of 2.5mm<sup>2</sup>, 12 awg (accepts a single conductor or stranded wire).

Ensure that a proper earth ground connection is made to the protective earth ground stud.

Refer to Figures 1 through 5 for connections.

## Common Services Module (CSM) with 24 VDC FCV

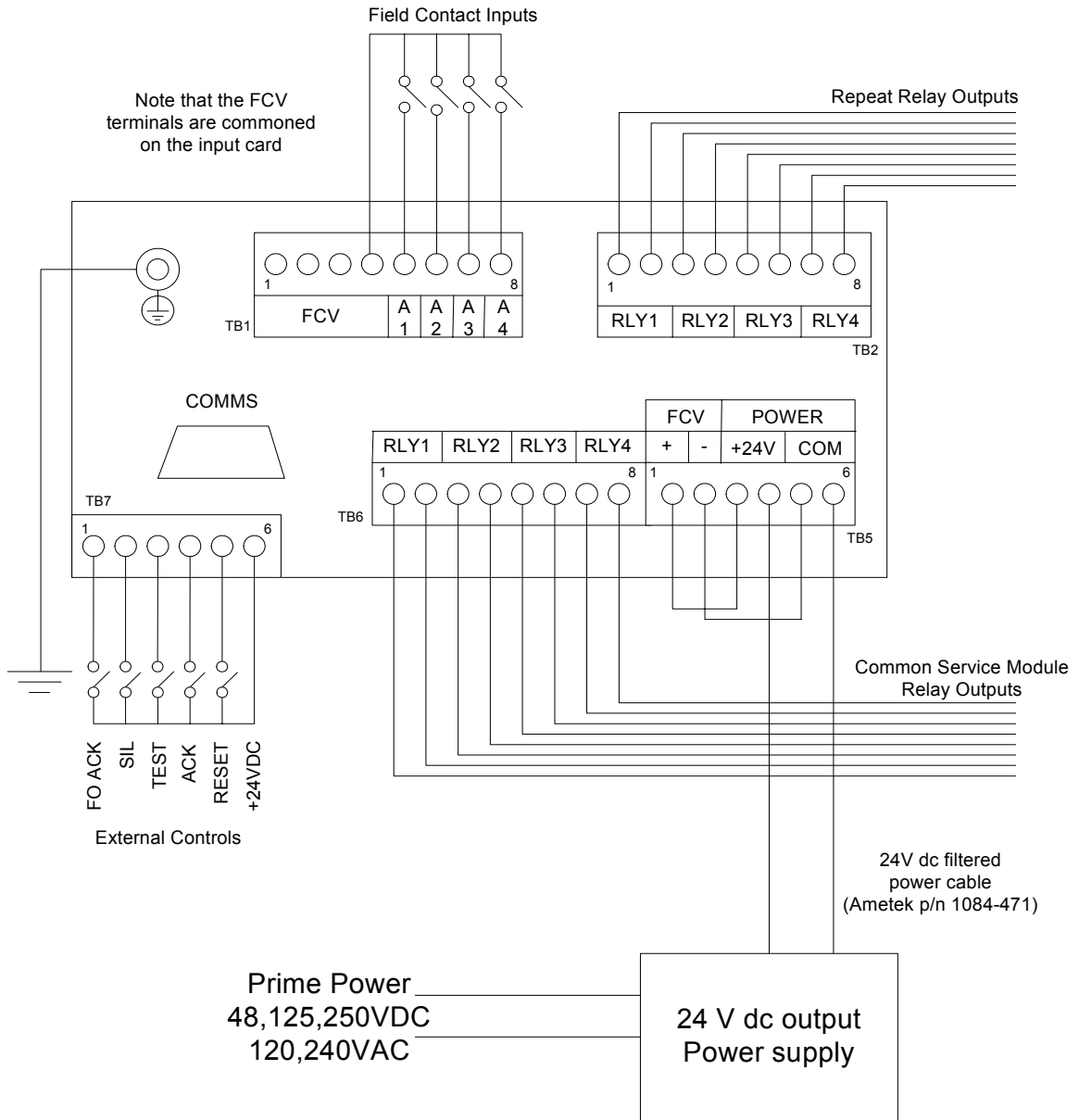

**Figure 1**

Input Usage	Small Windows	Medium Window	Large Window
<b>A1</b>	Point 1, Relay 1	Point 1, Relay 1	Point 1, Relay 1
<b>A2</b>	Point 2, Relay 2	Point 2, Relay 2	Not used
<b>A3</b>	Point 3, Relay 3	Not used	Not used
<b>A4</b>	Point 4, Relay 4	Not used	Not used

## Common Services Module (CSM) with External DC FCV

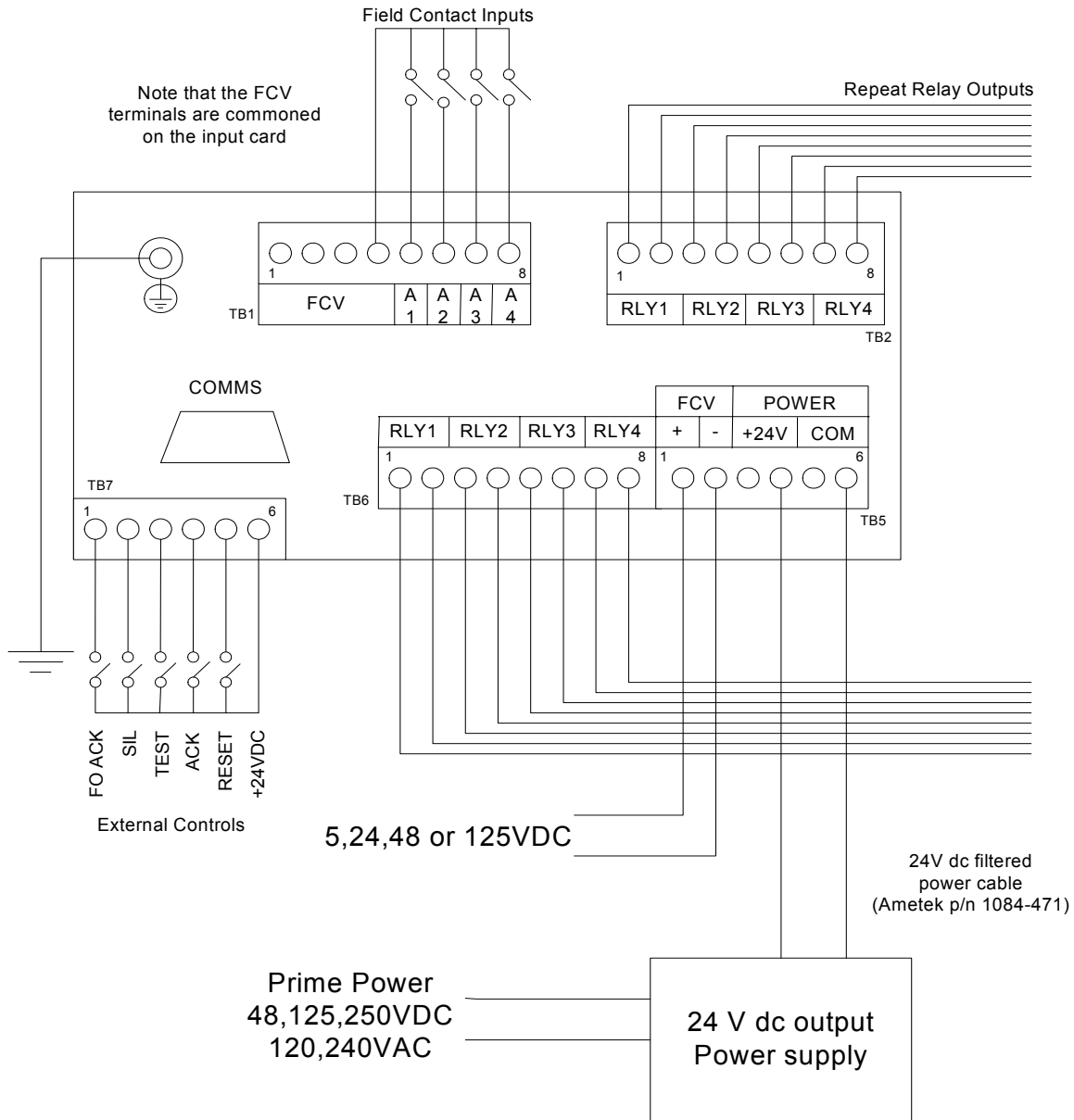

**Figure 2**

Input Usage	Small Windows	Medium Window	Large Window
<b>A1</b>	Point 1, Relay 1	Point 1, Relay 1	Point 1, Relay 1
<b>A2</b>	Point 2, Relay 2	Point 2, Relay 2	Not used
<b>A3</b>	Point 3, Relay 3	Not used	Not used
<b>A4</b>	Point 4, Relay 4	Not used	Not used

## Common Services Module (CSM) with Isolated FCV

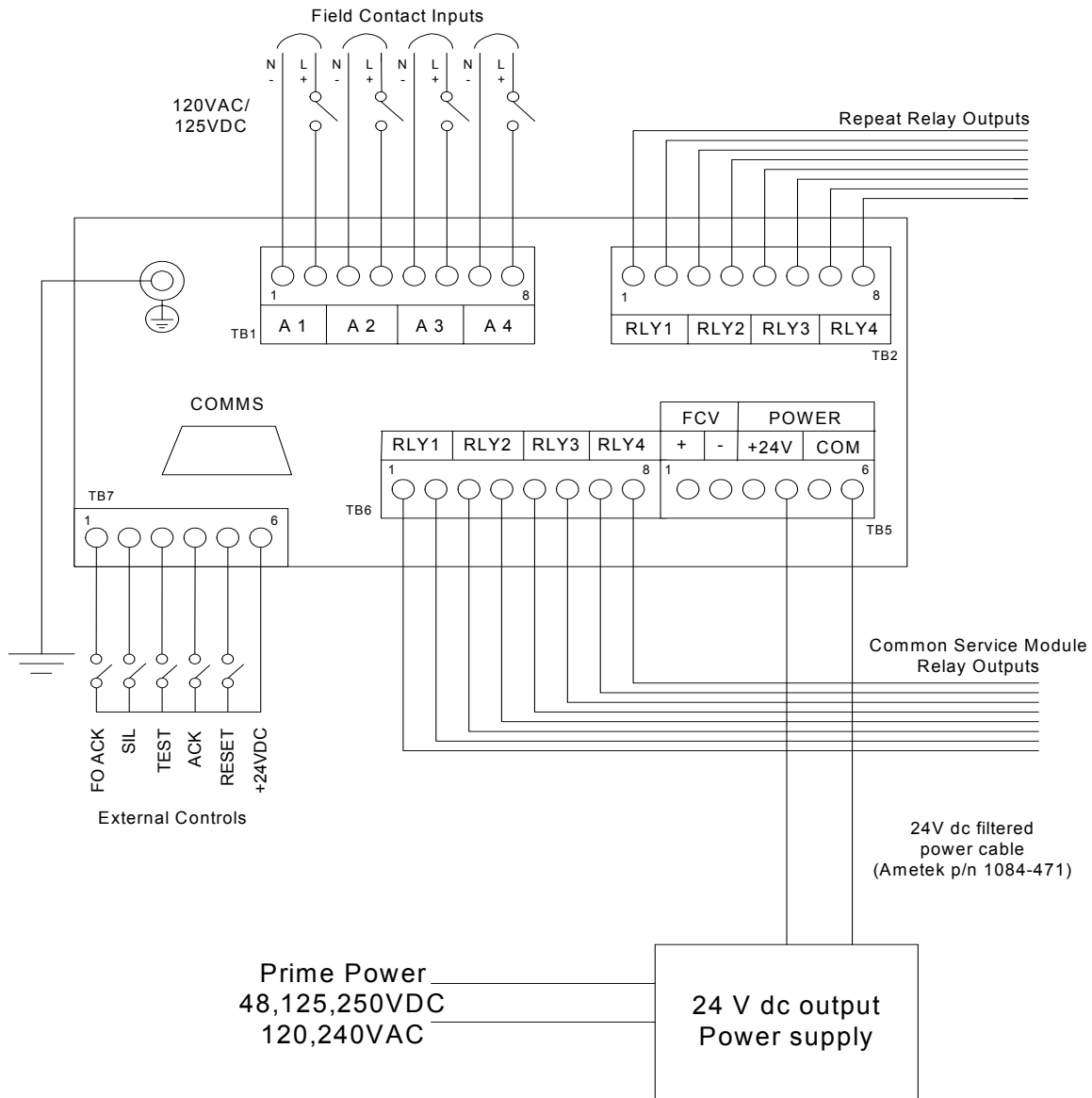
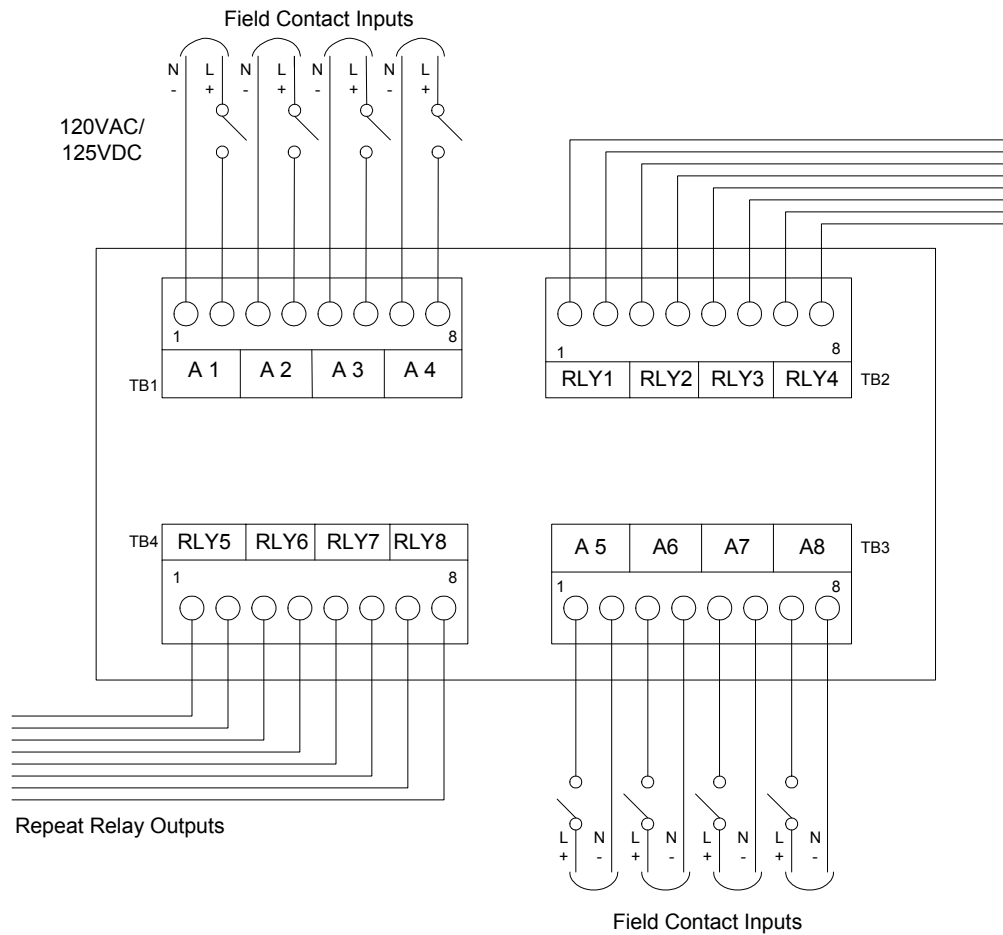

**Figure 3**

Input Usage	Small Windows	Medium Window	Large Window
<b>A1</b>	Point 1, Relay 1	Point 1, Relay 1	Point 1, Relay 1
<b>A2</b>	Point 2, Relay 2	Point 2, Relay 2	Not used
<b>A3</b>	Point 3, Relay 3	Not used	Not used
<b>A4</b>	Point 4, Relay 4	Not used	Not used



## Isolated Input Card



**Figure 4**

Input Usage	Small Windows	Medium Windows	Large Windows	Extra Large Window
<b>A1</b>	Point 1, Relay 1	Point 1, Relay 1	Point 1, Relay 1	Point 1, Relay 1
<b>A2</b>	Point 2, Relay 2	Point 2, Relay 2	Point 2, Relay 2	Not used
<b>A3</b>	Point 3, Relay 3	Point 3, Relay 3	Not used	Not used
<b>A4</b>	Point 4, Relay 4	Point 4, Relay 4	Not used	Not used
<b>A5</b>	Point 5, Relay 5	Card not fitted	Card not fitted	Card not fitted
<b>A6</b>	Point 6, Relay 6	Card not fitted	Card not fitted	Card not fitted
<b>A7</b>	Point 7, Relay 7	Card not fitted	Card not fitted	Card not fitted
<b>A8</b>	Point 8, Relay 8	Card not fitted	Card not fitted	Card not fitted

# DC Input Card

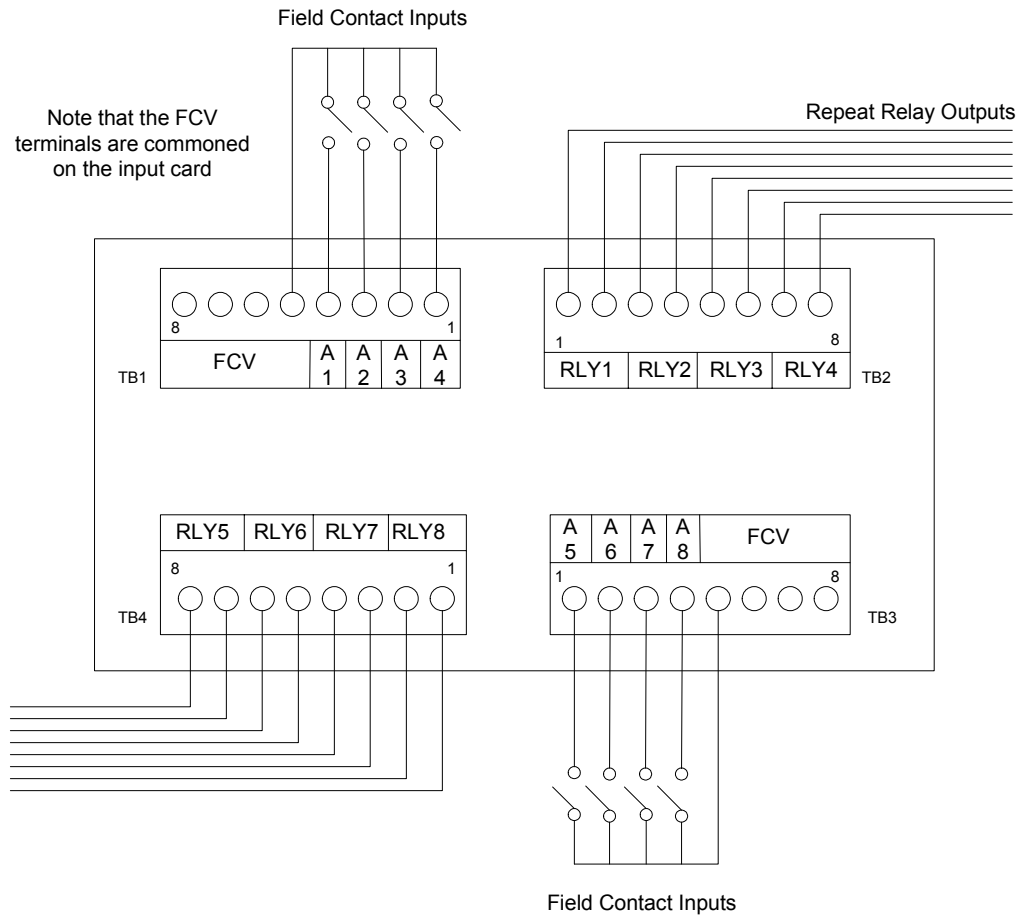

Figure 5

Input Usage	Small Windows	Medium Windows	Large Windows	Extra Large Window
<b>A1</b>	Point 1, Relay 1	Point 1, Relay 1	Point 1, Relay 1	Point 1, Relay 1
<b>A2</b>	Point 2, Relay 2	Point 2, Relay 2	Point 2, Relay 2	Not used
<b>A3</b>	Point 3, Relay 3	Point 3, Relay 3	Not used	Not used
<b>A4</b>	Point 4, Relay 4	Point 4, Relay 4	Not used	Not used
<b>A5</b>	Point 5, Relay 5	Card not fitted	Card not fitted	Card not fitted
<b>A6</b>	Point 6, Relay 6	Card not fitted	Card not fitted	Card not fitted
<b>A7</b>	Point 7, Relay 7	Card not fitted	Card not fitted	Card not fitted
<b>A8</b>	Point 8, Relay 8	Card not fitted	Card not fitted	Card not fitted

# INPUT HARDWARE CONFIGURATION

## FIELD CONTACT VOLTAGE (FCV)

For a DC system the FCV is normally derived from the internally supplied +24V DC connected via the CSM module. See Figure 1 above.

DC FCV can also be supplied externally as shown by Figure 2. The system is designed to operate with a positive FCV.

For AC systems there is no AN-6100C connection to an FCV source. See Figure 3.

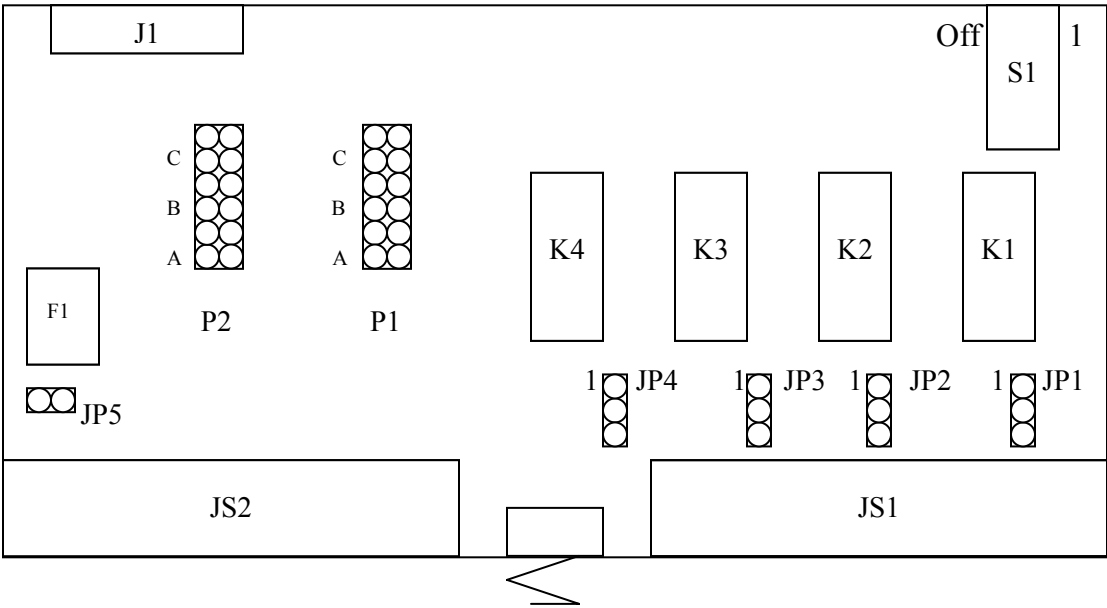

**Figure 6 Input Card Links and Switches**

## INPUT CARD LINKS AND SWITCHES

### *FCV selection*

(See Figure 6 above) The input card permits the FCV value used to be selected using links P2, P1 and JP5.

FCV and Input Selection		P1			P2		
FCV	JP5	A	B	C	A	B	C
Open Collector	In	Out	In	In	Out	In	In
5V (logic)	Out	In	In	In	In	In	In
24VDC	Out	Out	In	In	Out	In	In
48VDC	Out	Out	Out	In	Out	Out	In
125VDC	Out	Out	Out	Out	Out	Out	Out
120VAC/125VDC	N/A	Out	Out	Out	Out	Out	Out

**WARNING:** The 120VAC/125VDC input requires the Isolated Input Cards. This option should normally be specified at purchase. Layout and set up for these cards is as for the standard type except JP5 is not present.

**Note:** The open collector option is supplied from the AN6100C's internal 24VDC FCV supply. This should be connected as shown in figure 1 above.

**Note:** The above table assumes that all inputs are set for the same voltage. Ametek would caution against attempting a mixed input set up.

### *Input Contact Selection*

This is done using S1.

Input	4 (5)	3 (6)	2 (7)	1 (8)
Switch	S1/1	S1/2	S1/3	S1/4
Normally Open	On	On	On	On
Normally Closed	Off	Off	Off	Off

**Note:** A normally open input will close in the alarm condition.

**Note:** Figures in brackets are for inputs 5 through 8 located on the 2<sup>nd</sup> input card within the cell (if installed).

## Relay Output Mode Selection

The optional Repeat Relays shall be configured as shown in the table below:

Model Code	Relay Operation Mode	Relay Contact Status (shown in Normal State)	Relay Coil Status (shown in Normal State)
FOE	Repeat Relay Output Follows Input Contact State	OPEN (Form A)	ENERGIZED
FOD		OPEN (Form A)	DE-ENERGIZED
FCE		CLOSED (Form B)	ENERGIZED
FCD		CLOSED (Form B)	DE-ENERGIZED
MOE	Repeat Relay Output Latches on Alarm until Acknowledged or Reset	OPEN (Form A)	ENERGIZED
MOD		OPEN (Form A)	DE-ENERGIZED
MCE		CLOSED (Form B)	ENERGIZED
MCD		CLOSED (Form B)	DE-ENERGIZED

### REPEAT RELAY CONTACT STATUS SETUP

Output Link	4 (5) JP1	3 (6) JP2	2 (7) JP3	1 (8) JP4
Form A (Normally Open Contact)	2,3	2,3	2,3	2,3
Form B (Normally Closed Contact)	1,2	1,2	1,2	1,2

**Note:** The Relay Outputs consist of SPDT Relays with selectable contact outputs (Form A or Form B). These links select the relay contact pair connected to the output terminals. The options for the Relay Operation Mode and Relay Coil Status (normally energized or de-energized relays) are selected using the software configuration tool. (Reference the instruction manual section for Software Configuration. Figures in brackets are for inputs 5 through 8 located on the 2nd input card within the cell (if installed).

## CSM CARD LINKS

### Relay Output Mode Selection

Output Link	1 JP1	2 JP2	3 JP3	4 JP4
Form A (Normally Open Contact)	2,3	2,3	2,3	2,3
Form B (Normally Closed Contact)	1,2	1,2	1,2	1,2

**Note:** The Relay Outputs consist of SPDT Relays with selectable contact outputs (Form A or Form B). These links select the relay contact pair connected to the output terminals. The options for normally energized or de-energized relays are selected using the software

configuration tool. The table describes the de-energized state.

## Serial Comms Selection

This can be set for RS232 or RS485 operation and is done using the P10 links.

Operation Mode	P10						
RS232	B1,C1	B2,C2	B3,C3	B4,C4	B5,C5	B6,C6	B7,C7
RS485	B1,A1	B2,A2	B3,A3	B4,A4	B5,A5	B6,A6	B7,A7

An RS485 terminator is provided if required. This is enabled with P11

Terminator	P11
In	1,2
Out	2,3

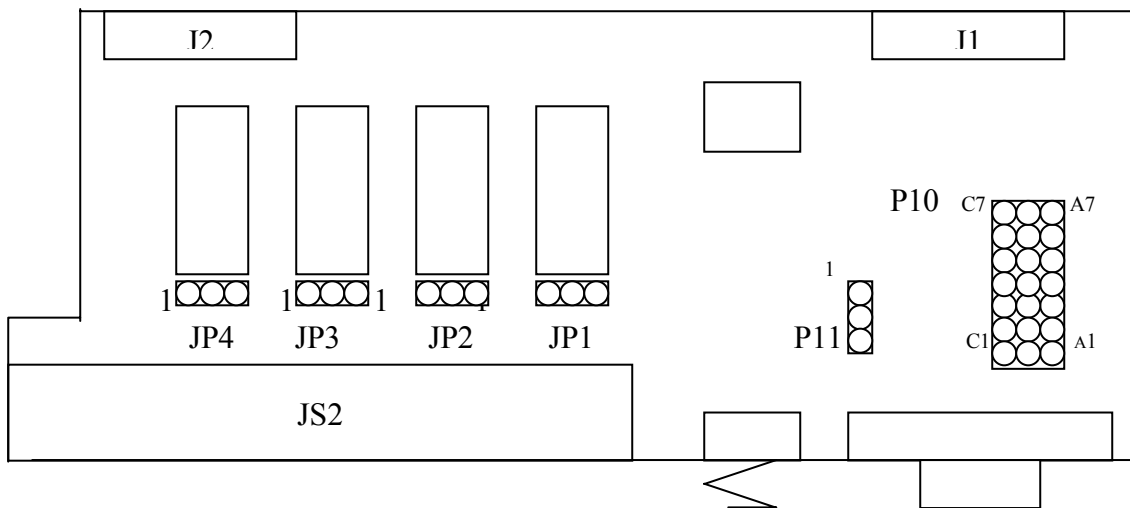

Figure 7 CSM Card Links

## Serial Comms Connection

This is via the DB9 connector on the rear.

Pin	1	2	3	4	5	6	7	8	9
RS232	nc	TX	RX	nc	GND	nc	RTS	nc	nc
RS485	nc	TX/RX+	TX/RX-	nc	GND	nc	RTS	nc	nc

# POWER SUPPLY

## Connecting Power

For compliance with UL requirements, a switch or circuit breaker *must* be installed within close proximity to the unit as a means of disconnecting power. If you choose to protect the input power line externally, use a breaker rated for 2.5 amps @120VAC, 240VAC or 125VDC as required on the primary power connection. (Note: This is the maximum current draw for a 5 High by 5 Wide Annunciator. Reference the power requirements below for your power consumption.).

The AN-6100C operates from a nominal 24V DC supply. The operating voltage range is 20 to 28V DC. A standard range of separate power supply units are available (AN-6100 Series) to enable the AN-6100C to be powered from 110/240 Volt 50/60Hz AC, or 48V, 125V and 250V DC. See Below to establish total system burden requirements

### **PLEASE NOTE**

**Note a 24V DC power filter cable is supplied and must be used to ensure the annunciator is immune to transients up to EN 61000-4 level 3, and that the annunciator meets IEC61000-6-3 Class B emissions**  
**(RiS Part No 1084-471)**

## POWER REQUIREMENTS

Maximum Burden per Module at 24 Volts DC. (Current in A)

AN6100C Power Consumption (Amps @ 24 Vdc)						
8 Inputs/ 8 Relays per Cell (All Points Alarmed)						
		Height (Cells)				
		1	2	3	4	5
Width (Cells)	1	0.25	0.55	0.85	1.15	1.45
	2	0.55	1.15	1.75	2.35	2.95
	3	0.85	1.75	2.65	3.55	4.45
	4	1.15	2.35	3.55	4.75	5.95
	5	1.45	2.95	4.45	5.95	7.45

**Note:** This is the maximum current draw for a system with 8 inputs per cell and repeat relays. Systems with less inputs or no relays will have a slightly lower current draw. Burden does not include auxiliary output loads.





# AVAILABLE SEQUENCES

The following are summary sequence descriptions provided for guidance. For rigorous definitions consult the system itself or apply to AMETEK for clarification.

AUTO RESET, NON LOCKING STATUS ONLY INDICATION						
SEQUENCE CODE	ALARM DEVICE	NORMAL	ALERT	ACKNOWLEDGE	RETURN TO NORMAL	RETURN TO NORMAL BEFORE ACK
<b>A-456</b>	VISUAL					
	AUDIBLE					

AUTO RESET, NON LOCKING						
SEQUENCE CODE	ALARM DEVICE	NORMAL	ALERT	ACKNOWLEDGE	RETURN TO NORMAL	RETURN TO NORMAL BEFORE ACK
<b>A-4</b>	VISUAL					
	AUDIBLE					

AUTO RESET, LOCKING							
SEQUENCE CODE	ALARM DEVICE	NORMAL	ALERT	ACKNOWLEDGE	RETURN TO NORMAL	RETURN TO NORMAL BEFORE ACK	ACKNOWLEDGE
<b>A</b>	VISUAL						
	AUDIBLE						

MANUAL RESET, LOCKING								
SEQUENCE CODE	ALARM DEVICE	NORMAL	ALERT	ACKNOWLEDGE	RETURN TO NORMAL	RETURN TO NORMAL BEFORE ACK	ACKNOWLEDGE	RESET
<b>M</b>	VISUAL							
	AUDIBLE							

RINGBACK, DUAL FLASH, MANUAL RESET								
SEQUENCE CODE	ALARM DEVICE	NORMAL	ALERT	ACKNOWLEDGE	RETURN TO NORMAL	RETURN TO NORMAL BEFORE ACK	ACKNOWLEDGE	RESET
<b>R-12</b>	VISUAL							
	AUDIBLE							

\* A distinctly different ringback audible can be provided in most cases

FIRST OUT, AUTORESET												
SEQUENCE CODE	ALARM DEVICE	NORMAL	ALERT		ACKNOWLEDGE		RETURN TO NORMAL		RETURN TO NORMAL BEFORE ACK.		ACKNOWLEDGE	
			INITIAL	NEXT	INITIAL	NEXT	INITIAL	NEXT	INITIAL	NEXT	INITIAL	NEXT
<b>F1A</b>	VISUAL											
	AUDIBLE											

FIRST OUT WITH FIRST OUT RESET													
SEQUENCE CODE	ALARM DEVICE	NORMAL	ALERT		ACKNOWLEDGE		RETURN TO NORMAL		RETURN TO NORMAL BEFORE ACK.		ACKNOWLEDGE		RESET
			INITIAL	NEXT	INITIAL	NEXT	INITIAL	NEXT	INITIAL	NEXT	INITIAL	NEXT	
<b>F2M</b>	VISUAL												
	AUDIBLE												

FIRST OUT, MANUAL RESET													
SEQUENCE CODE	ALARM DEVICE	NORMAL	ALERT		ACKNOWLEDGE		RETURN TO NORMAL		RETURN TO NORMAL BEFORE ACK.		ACKNOWLEDGE		RESET
			INITIAL	NEXT	INITIAL	NEXT	INITIAL	NEXT	INITIAL	NEXT	INITIAL	NEXT	
<b>FFAM2</b> (RIS)	VISUAL												
	AUDIBLE												

FIRST OUT, TRIPLE FLASH, FIRST OUT RESET													
SEQUENCE CODE	ALARM DEVICE	NORMAL	ALERT		ACKNOWLEDGE		RETURN TO NORMAL		RETURN TO NORMAL BEFORE ACK.		ACKNOWLEDGE		FIRST OUT RESET
			INITIAL	NEXT	INITIAL	NEXT	INITIAL	NEXT	INITIAL	NEXT	INITIAL	NEXT	
<b>F3A</b>	VISUAL												
	AUDIBLE												

RINGBACK, DUAL LAMP, DUAL FLASH, MANUAL RESET – 2 WINDOWS PER POINT								
SEQUENCE CODE	ALARM DEVICE	NORMAL	ALERT	ACKNOWLEDGE	RETURN TO NORMAL	RETURN TO NORMAL BEFORE ACK	ACKNOWLEDGE	RESET
<b>R-12C</b>	VISUAL							
	AUDIBLE							

\* A distinctly different ringback audible can be provided in most cases

FIRST OUT, DUAL LAMP, FIRST OUT RESET – 2 WINDOWS PER POINT													
SEQUENCE CODE	ALARM DEVICE	NORMAL	ALERT		ACKNOWLEDGE		RETURN TO NORMAL		RETURN TO NORMAL BEFORE ACK.		ACKNOWLEDGE		FIRST OUT RESET
			INITIAL	NEXT	INITIAL	NEXT	INITIAL	NEXT	INITIAL	NEXT	INITIAL	NEXT	
<b>F3C</b>	VISUAL												
	AUDIBLE												

Dual Lamp sequences use only inputs 1 and 3 on each input card. Inputs 2 and 4 should not be connected.

RINGBACK, DUAL FLASH, LOCK IN UNTIL ACKNOWLEDGED						
SEQUENCE CODE	ALARM DEVICE	NORMAL	ALERT	ACKNOWLEDGE	RETURN TO NORMAL	RESET
<b>R</b>	VISUAL					
	AUDIBLE					

\* A distinctly different ringback audible can be provided in most cases

RINGBACK, DUAL LAMP, LOCK IN UNTIL ACKNOWLEDGED – 2 WINDOWS PER POINT						
SEQUENCE CODE	ALARM DEVICE	NORMAL	ALERT	ACKNOWLEDGE	RETURN TO NORMAL	RESET
<b>RC</b>	VISUAL					
	AUDIBLE					

\* A distinctly different ringback audible can be provided in most cases

Dual Lamp sequences use only inputs 1 and 3 on each input card. Inputs 2 and 4 should not be connected.

FIRST OUT, TRIPLE FLASH, FIRST OUT RESET											
SEQUENCE CODE	ALARM DEVICE	NORMAL	ALERT		ACKNOWLEDGE		RETURN TO NORMAL BEFORE ACK.		RETURN TO NORMAL AND RESET		RETURN TO NORMAL AND RESET RESET
			INITIAL	NEXT	INITIAL	NEXT	INITIAL	NEXT	INITIAL	INITIAL	
<b>F3M</b>	VISUAL										
	AUDIBLE										

FIRST OUT WITH FIRST OUT RESET									
SEQUENCE CODE	ALARM DEVICE	NORMAL	ALERT		ACKNOWLEDGE		RETURN TO NORMAL AND ACK.		RETURN TO NORMAL RESET
			INITIAL	NEXT	INITIAL	RESET	INITIAL	NEXT	
<b>F2A</b>	VISUAL								
	AUDIBLE								

For intermixed sequences specify IMO order code

**LEGEND**

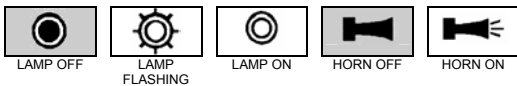



# CONFIGURATION

## INTRODUCTION

### *AN6100C*

The AN6100C is a flexible Annunciator. Most of the configuration of the system is made using software which makes the initial set up and any updates very simple. Only the input voltage range, N.O., N.C. input selection and relay contact outputs are selected with on-board switches.

### *Application*

The AN6100C Configuration application is used to create, edit and download annunciator configurations. It connects directly to the annunciator via a serial port on the PC. A configuration may be created without a connection to the annunciator and then downloaded later. The configuration information is held as a file on the PC which may be edited if a change is required. An exception to this is the physical size of the annunciator which includes the number of input modules and the size of each module, which is factory configured.

If a configuration is edited checks are made to ensure that the correct file is downloaded to the annunciator. If more than one version of the AN6100C configuration software is used then more than one version of the configuration file can exist. It is up to the user to ensure that copies of the configuration are kept up to date. If the application detects that the local and remote copies of a configuration are different the user can select update either.

The application also includes a function to enable the configurable options in the annunciator. One such is Modbus communications.

## SOFTWARE INSTALLATION

The AN6100C configuration software should be installed onto a PC with the following minimum configuration :-

- 300MHz Pentium II CPU
- Windows 98/2000/XP
- 64Mbytes RAM
- 20Gbytes hard disk

Insert the AMETEK AN6100C Configuration CD in the CD-ROM drive. This will automatically start the installation process. If this does not happen choose 'Run' from the 'Start' menu then browse to the CD-ROM drive and click on 'Autorun.exe'.

# SOFTWARE CONFIGURATION INSTRUCTIONS

*This is an overview of the configuration steps required for editing or creating an Annunciator configuration. Refer to the next section for additional detail on the menu selections.*

## *Reviewing or editing the Factory Configuration*

All Annunciators are factory configured per the model number. Some of these selections, such as Alarm Sequence can be changed with the configuration software. Other features not in the model number, such as Input Delay, CSM Relay Output Assignments can also be edited.

1. Connect serial null modem cable between the AN-6100C communication port and the PC with the Configuration Software installed.
2. Start up Configurator Software. If a default configuration appears, press Cancel.
3. Select Connections, then Settings and configure your PC Serial port for the Com Port where your serial cable is plugged into, 9600 Baud, no parity and address 1
4. Select Connections, then Connect. If successful, the Annunciator lights will flash fast and a pop up screen will appear with your serial number. Press OK.
5. If you see a screen that says 'Configuration Mismatch', select Download Configuration from the Annunciator.
6. Select File, Start Wizard and this will show how the Annunciator is currently configured. You can make changes to any of the selections. For more detail on any of the selection, refer to the next section on the Configuration Wizard.
7. When finished making any changes, select save and enter the file name if prompted. Select Connections, Configuration, Write Configuration. When it is complete, select Connection, Disconnect.  
Note: There are ICONS on the Toolbar for many of the functions above.

## *Creating a new Configuration*

New configurations may be created both on-line (connected to an Annunciator) or off-line. In either case, start the configuration software and select File, New. From here, you can pick the Annunciator size and all other selections, as shown in the previous paragraph.

**Note:** The serial Modbus configuration is only shown after connecting to an Annunciator that includes this option. If you want to see an example of the Modbus selections available, there are some default configurations on you CD that include examples of systems with Modbus.

# MENUS

## *Main menu overview*

The main application window comprises of five main menus, File, Options, View, Connections and Help. These appear at the top of the screen above the application toolbar which provides quick access to the main functions of the program.

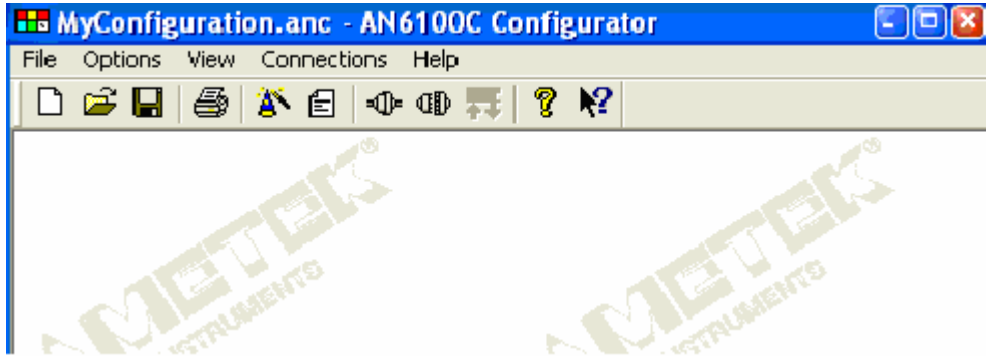

### *File Menu*

The program manages configuration files through the File Menu. From this menu, you can open, save, and delete configuration files. The File Menu also provides you access to a new "default" configuration as a point of reference.

### *Options Menu*

This menu provides functionality to alter the way your program behaves and appears.

### *View Menu*

Here you can select what you see in main window. Status bar, Tool bar etc.

### *Connections Menu*

Connections menu performs the actual communication with the annunciator to download or retrieve configurations.

### *Help Menu*

The Annunciator Configurator is equipped with a Help Menu to provide the user with assistance for each screen and program function.

## FILE

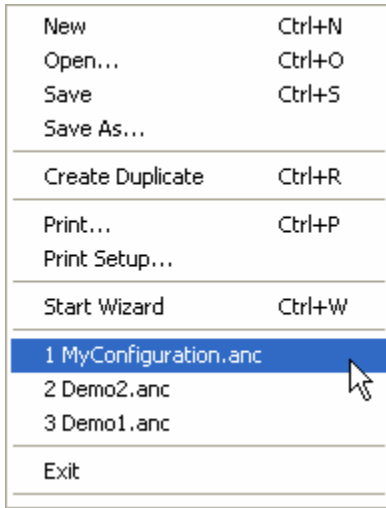

In the File menu you will find the following menu options:

### ***New***

Clicking on this will create and open a new configuration. As only one configuration can be open at a time, any previous configuration that is open will be closed. You will be prompted to save any changes before the configuration is closed. New configurations are set to the defaults.

### ***Open***

Here you can browse available locations on your system to open existing configuration files. (file extension ".anc").

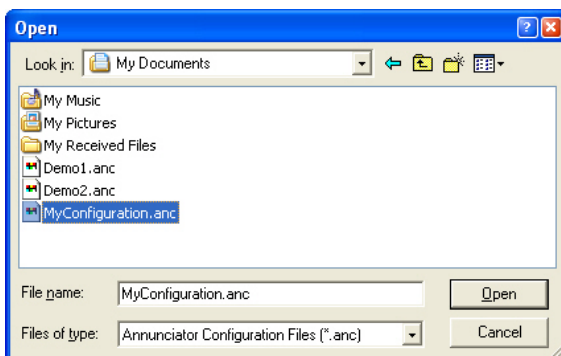



## **Save**

Allows you to save the active configuration file. If the configuration file has already been saved, it will automatically write over the old version.

## **Save As**

Allows you to save the active configuration file. When clicked, it will ask you for a filename before proceeding. If the filename already exists, it will ask you if you want to overwrite the old version.

## **Create Duplicate**

This will create and open a new configuration file, the parameters will be copied from the active (open) configuration and not set to defaults. This allows the same configuration settings to be downloaded to two annunciators.

## **Print**

This allows you to print the configuration in a text form so that you can see all the parameters. The printout is marked with the time and date of printing.

## **Print Setup**

This allows you to change your printer settings.

## **Start Wizard**

This will start the configuration wizard which will guide you through a set of screens to simply setup your annunciator.

## **Recent Files**

At the bottom of the file menu, you will also find a list of you most recent configuration files. You can simply click on one of these to open it.

# OPTIONS

Preferences
View Configuration Ctrl+W
Upgrade

## *Preferences*

In the preferences menu you can change the color setup of the whole application, and tell the program how you want the wizard to behave.

## *View Configuration*

This is a textual overview of the complete configuration.

## *Upgrade*

This menu option will allow you to add extra functionality to your annunciator and the configurator.

## **Preferences**

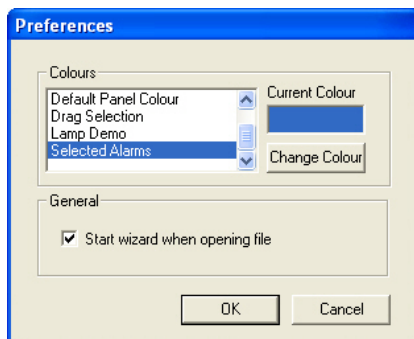

## *Colors*

The colors used to indicate various selections used in the configuration software may be changed. This may be required if they conflict with colors used in the Windows desktop. For most installations the default colors will be acceptable.

To change a color first select its usage from the list then click on 'Change Color' and select the new choice from the palette.

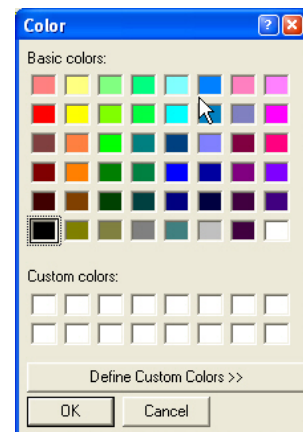

## ***General***

If the box beside "Start wizard when opening file" is checked, the wizard will automatically appear every time a new or existing document is opened. As the last open configuration is loaded when the application starts it means that the wizard will also automatically start at this point.

## ***View Configuration (Text)***

This allows you to see the complete configuration as text. Once this dialog is shown there are a number of options available.

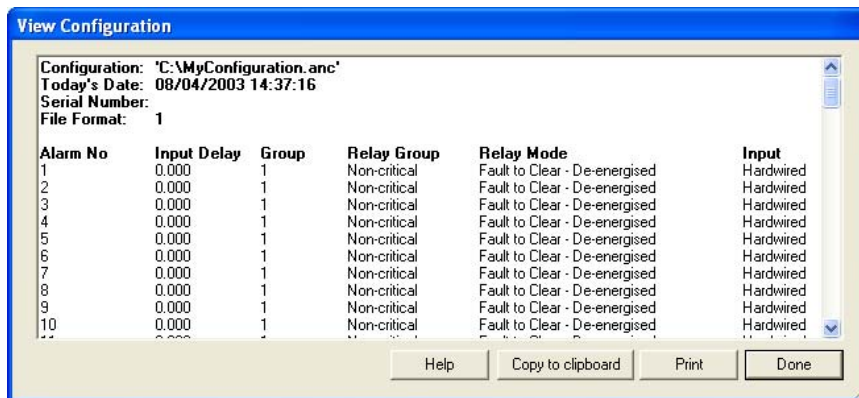

### ***Copy to clipboard***

You can use the mouse to select a portion of the configuration and then copy the selection to the clipboard so you can paste it into other documents. If you do not select any text the whole configuration is then copied.

### ***Print***

This will print the complete configuration.

## Upgrade

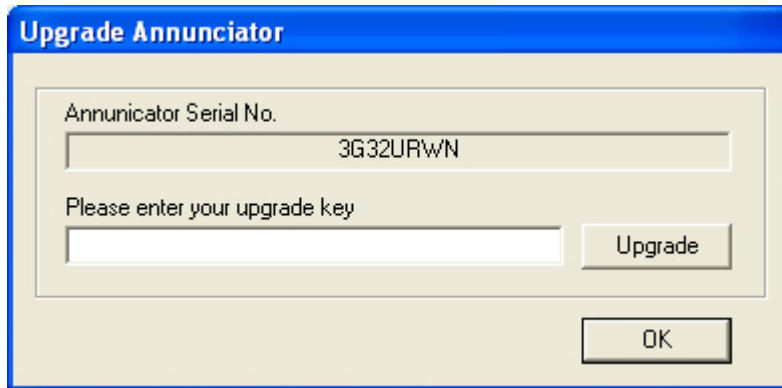

Upgrade Annunciator

Annunciator Serial No.  
3G32URWN

Please enter your upgrade key

Upgrade

OK

The application also includes a function to enable the configurable options in the annunciator. One such is Modbus communications.

To enable any of these options you must contact AMETEK Power Instruments with your annunciator serial number which you will find in the Upgrade dialog. You will be given a unique key which you must type into the box (shown above) and then click upgrade.

If you are connected to an annunciator the upgrade will be performed right away. If you are not connected then you must save the configuration and upload it at a later date.

**Note:**

To successfully obtain the serial number of the annunciator you must have uploaded the configuration at least once. If the configuration has never been uploaded to an annunciator you will get the following message where your serial ID should be.

*"This configuration has not been uploaded to an annunciator."*

## CONNECTIONS

Connect	Ctrl+C
Disconnect	Ctrl+D
Configuration	
Setting	
Connect Status	Ctrl+T

### *Connect & Disconnect*

From the connections menu you will be able to connect to or disconnect from your annunciator using the *Connect* and *Disconnect* menu options.

### *Configuration*

Once you have successfully connected to your annunciator you will be able to select the *Configuration* menu option. This will allow you to read and write configurations to and from the annunciator.

### *Settings*

Here you change your computer's settings to tell it how to connect to your annunciator.

**N.B. The annunciator functions will not operate while the configurator is connected to the AN6100C.**

## Configuration

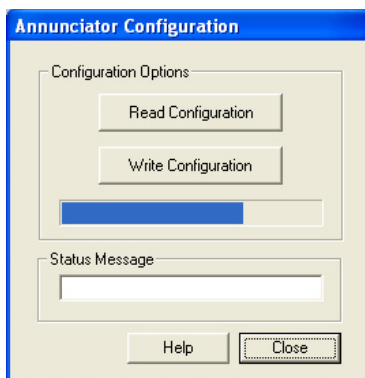

### *Read Configuration*

This copies the configuration from the annunciator into the active configuration. It is recommended that you save any configuration changes before reading a configuration. If you wish to discard your changes you can open another document or close the application opting not to save.

### ***Write Configuration***

This will copy the active configuration to the annunciator. It is recommended that you save any configuration changes before writing to the annunciator.

#### **Note:**

When a configuration is written to an annunciator the file is, from then on associated with that specific annunciator. As a result of this association, on subsequent sessions there are certain configuration options which will be disabled. They are listed below.

- System Name
- Number of rows
- Number of columns
- Alarms per module
- Number of hardwired inputs
- Input delay resolution

### ***Communication Settings***

From this dialog you can select the Com port wish to use to connect and the baud rate and parity of the connection, and the *address* of the annunciator.

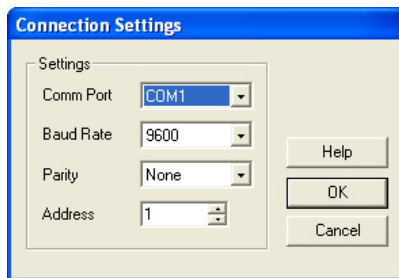

These values are stored independently of the annunciator hence care must taken be as if you have more that one annunciator they may not all have the same settings.

### ***Connect Status***

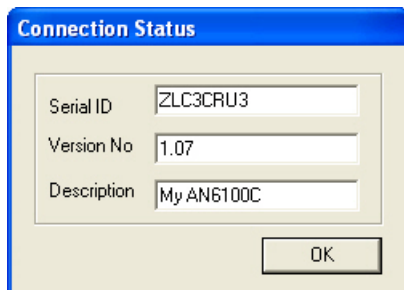

This option can be used when connected to retrieve the serial ID, the Hardware version and the system description. When nothing is connected the menu option is disabled. This can be used as an indicator to a successful connection.

## CONFIGURATION MISMATCH

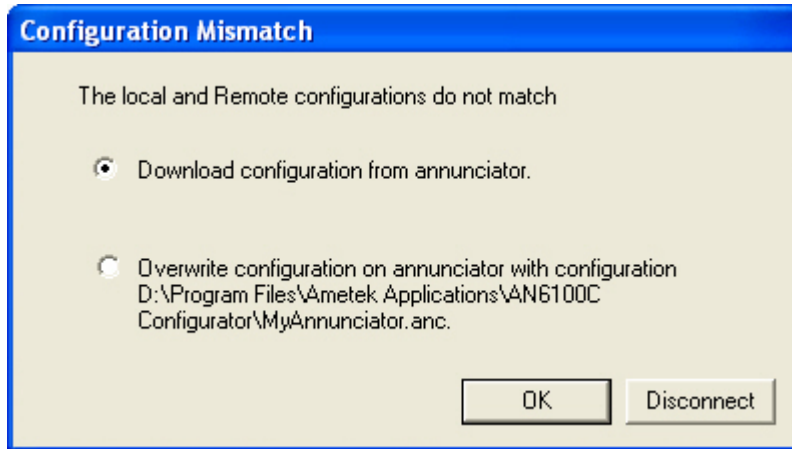

When you connect to an annunciator the program checks to see if the active file was the last configuration to be downloaded to the annunciator, if this is not the case then the message shown above will be displayed.

A Configuration mismatch may occur as a result of the following:

- 1) You have opened the wrong configuration file.
- 2) Someone else has downloaded a different configuration to the annunciator.

If you choose the first option "Download configuration from annunciator" this will copy the configuration from the annunciator in to the active file.

If you choose the second option "Overwrite configuration on annunciator with configuration....." this will copy the configuration in the active file to the annunciator.

In the case of a configuration mismatch it is recommended that you select the first option and then save this configuration to another location as a backup.

## SERIAL ID MISMATCH

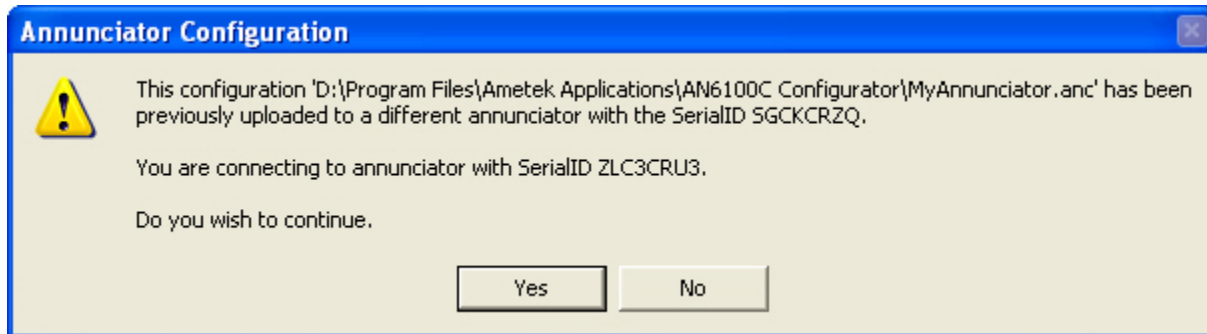

A serial ID mismatch occurs when you try to upload a configuration that has already been uploaded to another annunciator. When you upload a configuration, a note is kept of which annunciator it "belongs to". Every time you connect to an annunciator the stored serial ID is checked to make sure that it matches the annunciator you are connected to.

In the case of a serial ID mismatch if you hit continue you will be able to read the configuration from the annunciator but you will **not** be able to write the active one to the annunciator.

To rectify this situation you should click "No" and then open the correct configuration file, or create a new configuration.



## CONFIGURATION WIZARD

The configuration of an AN6100C is defined in a number of sections which are displayed on separate pages. The pages may be selected by clicking on the labeled tabs at the top of each page. When a system is configured for the first time the '*Next >>*' button may be used to move through all the sections. This will ensure that no sections are missed. The '<< *Back*' button may be used to go to the previous page if required.

A graphical representation of the annunciator is used to simplify the configuration. Individual or groups of inputs or modules can be selected by clicking on them. This mimic diagram may be given the same bezel colors as the actual unit to make correct input selection easy.

### System

The hardware configuration is defined in this page. The values **must** match the actual size of the AN6100C. A mimic diagram of the annunciator is shown on the left hand side. The blank section on the bottom right of the annunciator is the Common Service Module (CSM).

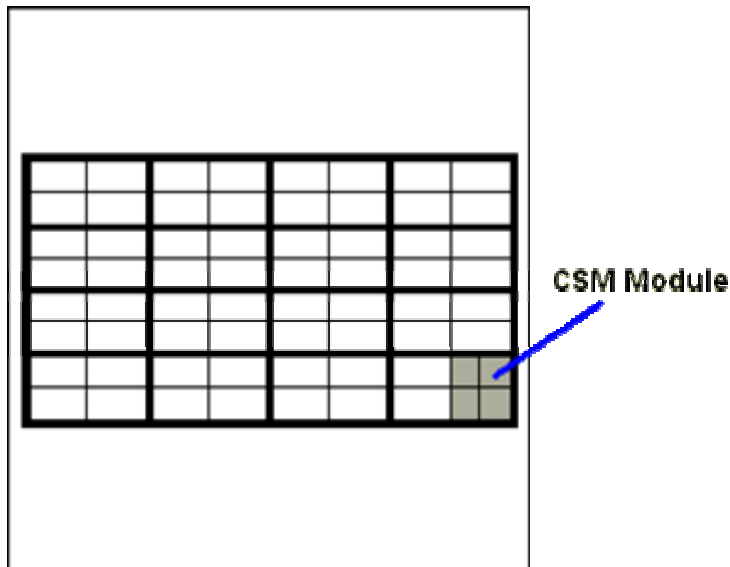

**N.B.** After the configuration is uploaded to the annunciator for the first time the system parameters cannot be edited. The controls will be disabled. Care should be taken that the System values are correct. To make a change, you must create a new configuration.

#### ***System Name (ID)***

This name is used to uniquely identify the annunciator. Up to 16 characters may be used for this.

### ***Rows and Columns of modules***

Use the up or down arrows to the right of each value to set the actual number of modules. The maximum size of an AN6100C is 5 rows by 5 columns.

### ***Alarm points per module***

There may be 1, 2, 4 or 8 points per module as determined by your window size. Small windows use 8 points, medium windows use 4, large windows use 2 and extra-large windows use 1 point per module. By default all modules have the same number of points. If different numbers of points per module are required click on the Advanced button.

### ***Hardwired inputs***

The default is that all inputs are hardwired, which refers to the field contacts wired to the back of the annunciator. On the mimic diagram the hardwired inputs are shown with a dot at the center. Non-hardwired inputs refers to inputs that are received via the serial communications. Non hard-wired inputs do not respond to the I/O cards or field contact inputs. In the Serial Input Only systems, the I/O cards are not even provided. Note: Serial Communications may be used for both Hardwired and Non-Hardwired systems.

### ***Input delay resolution***

This determines the system-wide increment value for the input delay for each alarm. You have 255 increments of the value selected. For 50ms, you can have a selectable software delay up to 12.5seconds. For 1sec, you have a selectable software delay up to 250seconds. Each input can have it's own delay assigned as shown in the Input Configuration page.

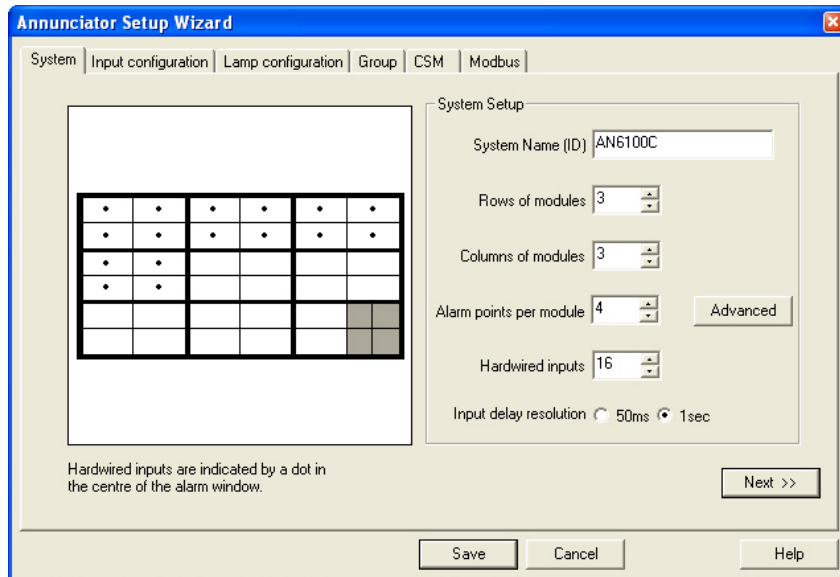

## Input Configuration

The configuration of each alarm input is defined in this page. To simplify this procedure a number of similar inputs may be selected at the same time and common parameters set.

An individual input is selected by clicking on it. The input will change color when selected. The input number will be shown in the 'Alarms' list. To select a number of inputs hold down the 'Ctrl' key while clicking on the inputs. To de-select an input press the 'Ctrl' key and click on the input again. To select a rectangular block of inputs click on the top left hand one then drag down to the bottom right.

When one or a number of inputs has been selected the parameters for those inputs may be set.

### Alarm Numbering

The inputs are numbered left to right and top to bottom. The inputs within a module are numbered in sequence followed by the next module. So, for example, the top row of inputs of modules with four inputs each are:-

1, 2, 5, 6, 9, 10, .....

Alarm numbering...

1	2	5	6		
3	4	7	8		

### ***Relay Mode (optional)***

If the repeat relay option has been included with your system, you may select the Relay Mode for each input as follows:-

#### Fault to Clear – Normally Energized

The repeat relay will follow the status of the field contact, regardless of the pushbuttons pressed. In this mode, the relay coil is energized in the normal (non-alarm) state.

#### Fault to Clear – Normally De-Energized

The repeat relay will follow the status of the field contact, regardless of the pushbuttons pressed. In this mode, the relay coil is de-energized in the normal (non-alarm) state.

#### Fault to Acknowledge – Normally Energized

The repeat relay will follow the status of the field contact until the acknowledge pushbutton is pressed, which returns the relay to the normal state. In this mode, the relay coil is energized in the normal (non-alarm) state.

#### Fault to Acknowledge – Normally De-Energized

The repeat relay will follow the status of the field contact until the acknowledge pushbutton is pressed, which returns the relay to the normal state. In this mode, the relay coil is de-energized in the normal (non-alarm) state.

#### Fault to Reset – Normally Energized

The repeat relay will follow the status of the field contact until the reset pushbutton is pressed, which returns the relay to the normal state. In this mode, the relay coil is energized in the normal (non-alarm) state.

#### Fault to Reset – Normally De-Energized

The repeat relay will follow the status of the field contact until the reset pushbutton is pressed, which returns the relay to the normal state. In this mode, the relay coil is de-energized in the normal (non-alarm) state.

**Note:** In addition to these configurations, the repeat relay contact may be selected as a Form A or (Normally Open) or Form B (Normally Closed) using the I/O jumpers described in the previous section.

### ***Alarm Group***

Each input belongs to one of 4 groups. The groups define the alarm sequences that are set in the 'Group' page. This allows up to 4 first out groups per system or four different sequences.

### ***Input delay***

This is the time for which an input has to change state before it is acknowledged. Each input may be set from 0 to 250s with a resolution of 1second, or from 0 to 12.5 with a resolution of 50milliseconds. The system wide input delay resolution (50ms or 1sec) is set on the System page.

**Note: These software delays are in addition to the fixed hardware filter of 40ms. For example; if a 50ms delay is selected, the total input delay is 90ms.**

### ***Critical alarm***

Alarms may be selected as critical or non-critical for activating a common alarm on the CSM. The CSM has relay outputs for critical or non-critical: horns, reflash and fault. Any input in the system selected for critical or non-critical will activate the respective CSM relay output. By default, all alarms are set as non-critical.

### ***Modbus Transmit or Receive (Optional)***

If the Modbus option is included with your system, every input is defined for Transmit or Receive by clicking on the button. Transmit implies that the alarm status from hardwired contacts are sent serially to some other device. Receive implies that some other serial device is providing the status of the alarm and the Annunciator will respond as if it were a field contact input. You may choose combinations of transmit and receive, but a single input can not do both. You may also set up an input as receive while providing a hard wired contact input to the same point. In this case, the Annunciator will respond to alarms from either the contact or serial input in a logic OR arrangement.

If the option is not available this button is not displayed. It may also not be displayed if creating a new configuration. You must connect to your Annunciator to enable the serial Modbus configuration.

**Note:** The data direction on Serial alarms (not Hardwired) can not be set to 'transmit'.

## Panel Colors

The color of each input in the mimic diagram may be changed to match the actual annunciator. To do this select all the inputs with the same color as described above then click on 'Panel Colors'. From the color selector dialog choose any color. The custom colors represent the available bezel colors. Repeat this for each color.

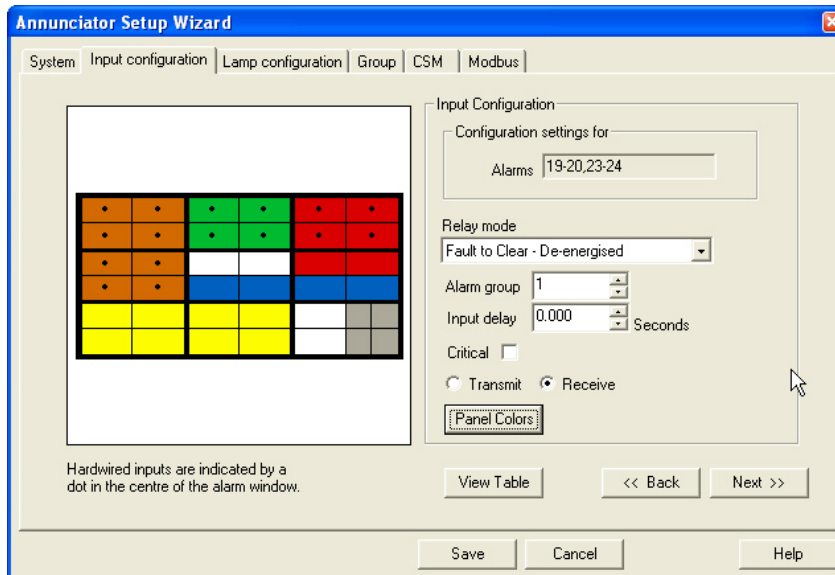

## Table View

Click on the Table View button to display the current input configuration in a table format. This is designed to be a summary of all the input configuration, but by clicking on the individual items you can actually change the selection from the table.

The column widths may be adjusted by clicking and dragging on the vertical separators between the column titles.

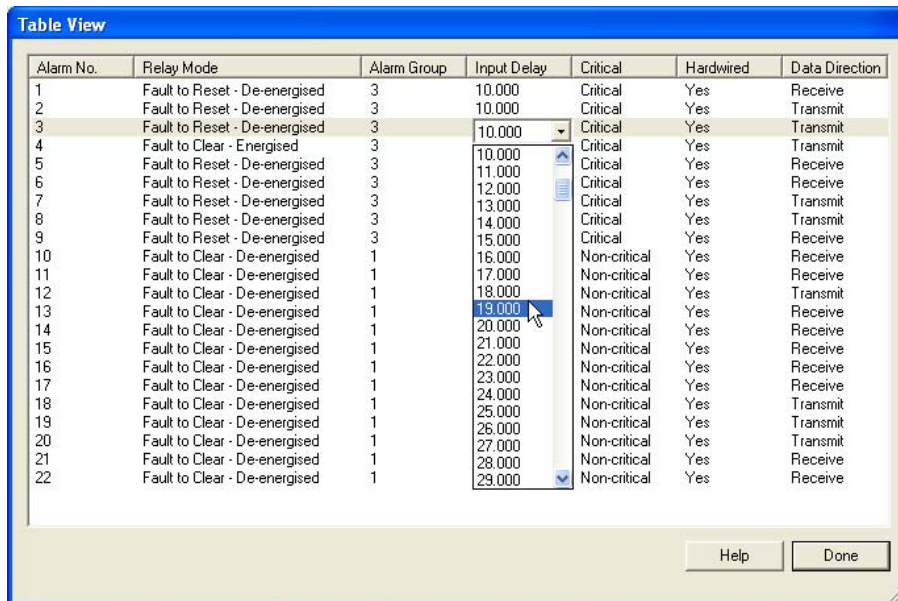

Alarm No.	Relay Mode	Alarm Group	Input Delay	Critical	Hardwired	Data Direction
1	Fault to Reset - De-energised	3	10.000	Critical	Yes	Receive
2	Fault to Reset - De-energised	3	10.000	Critical	Yes	Transmit
3	Fault to Reset - De-energised	3	10.000	Critical	Yes	Transmit
4	Fault to Clear - Energised	3	10.000	Critical	Yes	Transmit
5	Fault to Reset - De-energised	3	10.000	Critical	Yes	Receive
6	Fault to Reset - De-energised	3	11.000	Critical	Yes	Receive
7	Fault to Reset - De-energised	3	12.000	Critical	Yes	Transmit
8	Fault to Reset - De-energised	3	13.000	Critical	Yes	Transmit
9	Fault to Reset - De-energised	3	14.000	Critical	Yes	Receive
10	Fault to Clear - De-energised	1	15.000	Critical	Yes	Receive
11	Fault to Clear - De-energised	1	16.000	Non-critical	Yes	Receive
12	Fault to Clear - De-energised	1	17.000	Non-critical	Yes	Receive
13	Fault to Clear - De-energised	1	18.000	Non-critical	Yes	Transmit
14	Fault to Clear - De-energised	1	19.000	Non-critical	Yes	Receive
15	Fault to Clear - De-energised	1	20.000	Non-critical	Yes	Receive
16	Fault to Clear - De-energised	1	21.000	Non-critical	Yes	Receive
17	Fault to Clear - De-energised	1	22.000	Non-critical	Yes	Receive
18	Fault to Clear - De-energised	1	23.000	Non-critical	Yes	Receive
19	Fault to Clear - De-energised	1	24.000	Non-critical	Yes	Transmit
20	Fault to Clear - De-energised	1	25.000	Non-critical	Yes	Transmit
21	Fault to Clear - De-energised	1	26.000	Non-critical	Yes	Transmit
22	Fault to Clear - De-energised	1	27.000	Non-critical	Yes	Receive
			28.000	Non-critical	Yes	Receive
			29.000	Non-critical	Yes	Receive

## Lamp Settings

The lamp flashing sequences are defined in this page. Click on the up or down arrows

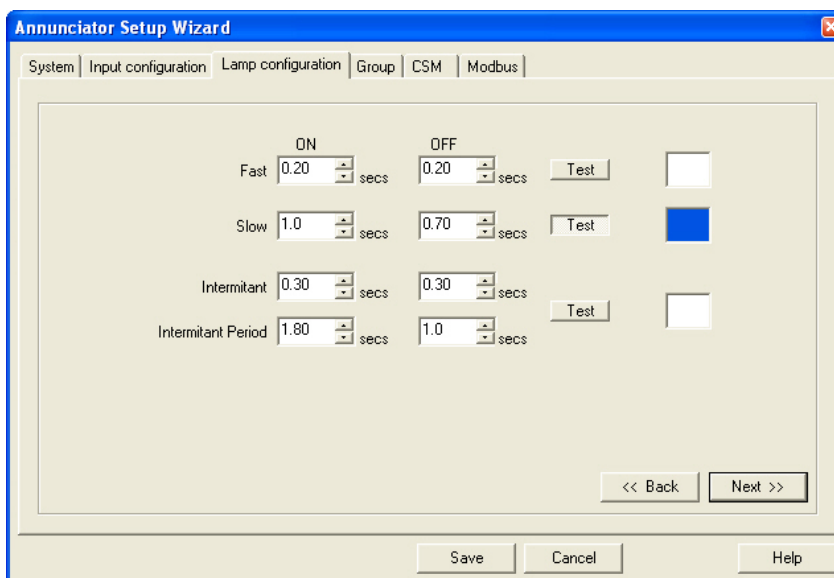

Annunciator Setup Wizard

System | Input configuration | Lamp configuration | Group | CSM | Modbus

ON OFF

Fast 0.20 secs 0.20 secs Test

Slow 1.0 secs 0.70 secs Test

Intermittant 0.30 secs 0.30 secs Test

Intermittant Period 1.80 secs 1.0 secs Test

<< Back Next >>

Save Cancel Help

beside each number to increment or decrement it. Click and hold on the arrows to scroll up or down. Click on the 'Test' button to check the appearance of each flash rate.

### ***Fast & Slow flash rates***

The ON and OFF times are set up with a resolution of 0.1s. The maximum times are 4s.

### ***Intermittent rate***

The Intermittent period values will be automatically adjusted to ensure they are integer multiples of the sum of the Intermittent ON and OFF times. The maximum Intermittent Period ON and OFF values are 25s.

### **Note:**

The **intermittent on period** may be adjusted automatically by the wizard so that it is set to at least one full intermittent on - off cycle.

## **Group Settings**

The alarm sequence for each input group is defined in this page. To change the alarm sequence click on the entry then choose the new entry from the list. The alarm sequences shown below follow ISA Standard S18.1 – 1979 (R.1985).

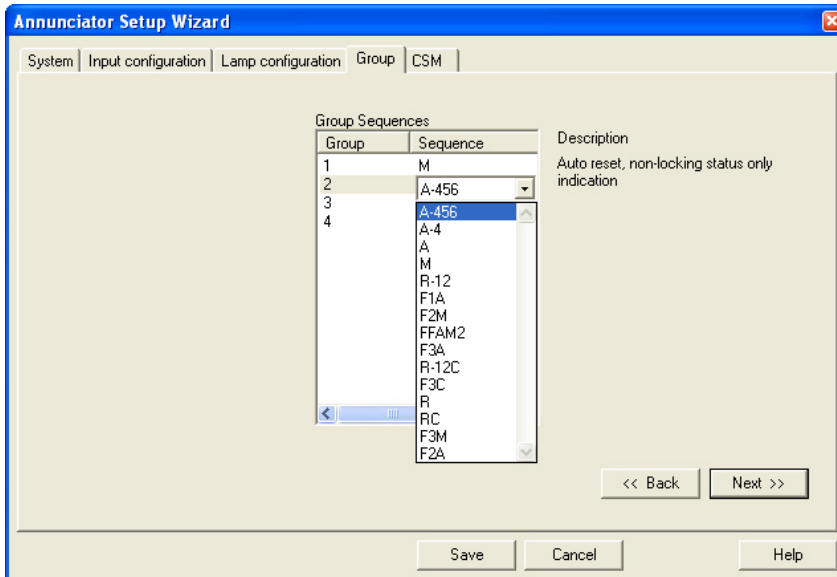



## **Common Service Module (CSM)**

The functions of the CSM are defined in this page.

### **Common Relay**

There are 4 relays in the CSM. Each relay mode may be defined as either Energized or De-Energized, with respect to the power on, normal state. For example, a Energized Relay has a coil that is energized when power is applied and there is no alarm. When the output is activated, the coil will de-energize, transferring the contact output. The relay functions may be selected from :-

Critical horn	Auxiliary horn output driven by any alarm selected as critical. The horn relay output will return to it's normal state upon activation of the silence or acknowledge pushbutton.
Non-critical horn	Auxiliary horn output driven by any alarm selected as non-critical. The horn relay output will return to it's normal state upon activation of the silence or acknowledge pushbutton. Note: If a critical horn is used in addition to the non-critical horn, the critical horn has priority. For example; if the non-critical alarm is on and the Annunciator receives a critical alarm, the non-critical horn will turn off and the critical horn will turn on. When the critical horn is silenced, any new non-critical alarms will activate the non-critical horn. This operation can be changed in the common functions below.
Critical re-flash	Grouped output driven by any alarm selected as critical. Upon a critical alarm, the relay output changes state. Every new critical alarm will pulse the relay output for approximately ½ second. The relay output will return to it's normal state when all critical alarms have returned to normal.
Non-critical re-flash	Grouped output driven by any alarm selected as non-critical. Upon a non-critical alarm, the relay output changes state. Every new non-critical alarm will pulse the relay output for approximately ½ second. The relay output will return to it's normal state when all critical alarms have returned to normal.

- Critical fault** This relay output will change state when any critical input is in the alarm state. The relay output will only return to its normal state when all critical alarms have returned to normal. The relay output is not affected by the silence or acknowledge pushbutton.
- Non-critical fault** This relay output will change state when any non-critical input is in the alarm state. The relay output will only return to its normal state when all non-critical alarms have returned to normal. The relay output is not affected by the silence or acknowledge pushbutton.
- Ringback** (clear horn) An output driven by the return to normal of an alarm input. Operated by sequences R, RC, R12 and R12C only.
- Watchdog** System healthy output. It will activate when the system is not processing alarms, like during the configuration process or when the power fails.

The Configuration Screen will show a summary of the Common Relay functions to the right. To select a relay to edit use the up or down arrows beside the relay number or click on the entry in the summary.

**Note:** In addition to these configurations, the repeat relay contact may be selected as a Form A or (Normally Open) or Form B (Normally Closed) using the I/O jumpers described in the previous section.

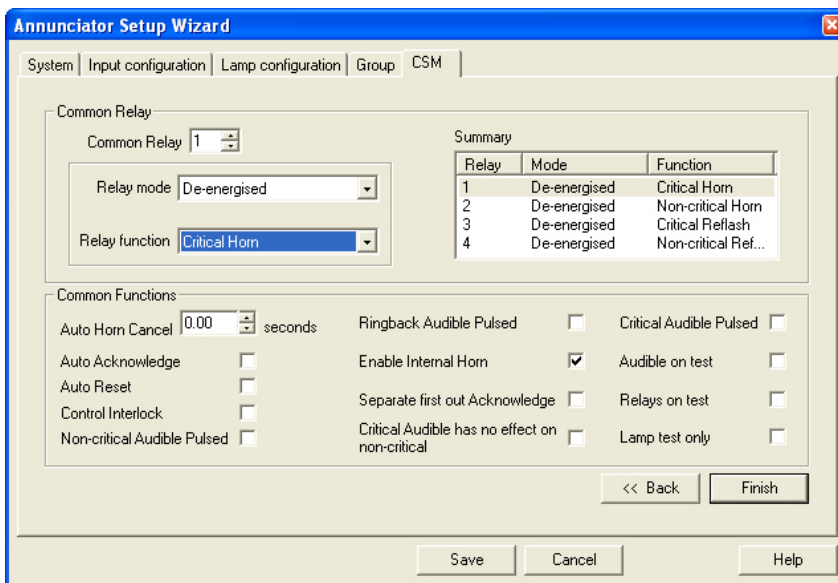

## ***Common Functions***

A number of functions are available for the Common Service Module as On/Off switches. To select a function click on the white box to the right of the name so as a tick mark appears. To turn the function off click on the box again so as the tick is removed. The available functions are :-

### **Auto Horn Cancel**

The horn alarm may be automatically canceled after a fixed time. Use the up and down arrows to the right of the value beside 'Auto Horn Cancel' to set the required time. The maximum value is 60s and the resolution is 0.25s. This will affect all horn outputs. (Critical, non-critical, and ringback)

### **Auto Acknowledge**

This will activate the acknowledge function continuously, eliminating the need to manually press this. (Note: by selecting this, you will never get any horn outputs and flashing lamps, depending on the sequence selected.)

### **Auto Reset**

This will activate the reset function continuously, eliminating the need to manually press this. (Note: this only applies to alarm sequences that require the reset function.)

### **Control Interlock**

This requires that the Silence, Acknowledge and Reset pushbuttons are pressed in this exact order. Anything else will be ignored. For example; if the Acknowledge pushbutton is pressed before the Silence, it will not have any effect. (Note: If the Reset function is not required for the alarm sequence selected, it will be ignored.)

### **Non-critical Audible Pulsed**

This will pulse the non-critical audible output upon an alarm.

### **Ringback Audible Pulsed**

This will pulse the ringback audible output upon an alarm.

### **Audible on test**

If selected, the audible outputs (critical, non-critical and ringback horn) will be activated during the Test Function.

### **Relays on test**

If selected, the Repeat Relay outputs will be activated during the Test Function.

### **Lamp test only**

If selected, only the lamps will be activated during the Test function.

### **Separate first out Acknowledge**

This allows the connection of an external pushbutton to acknowledge first out alarms only.

### **Critical Audible has no affect on non-critical**

This will make the operation of the non-critical horn independent of the critical horn. See the previous section on the operation of the non-critical audible.

Enable internal horn

When selected, this will activate the internal audible device upon any non-critical, critical or ringback horn condition.

Critical Audible Pulsed

This will pulse the critical audible output upon an alarm.

## Modbus

**Note:** These options will only be available if the Modbus functionality has been purchased from Ametek.

Default values of the modbus settings are given in appendix A

The screenshot shows the 'Modbus' tab of the 'Annunciator Setup Wizard'. The window title is 'Annunciator Setup Wizard'. The tabs at the top are: System, Input configuration, Lamp configuration, Sequence, CSM, Pushbuttons, DNP 3.0, and Modbus. The Modbus configuration area is divided into two columns. The left column contains: IP Address (192 . 168 . 0 . 1), Subnet Mask (255 . 255 . 255 . 0), Default Gateway (0 . 0 . 0 . 0), Receive Start Address (40001), and Transmit Start Address (40001). The right column contains: Parity (None), Baud Rate (9600), Modbus Mode (Slave), Data Type (Point), Modbus Address (1), Transmit Controls (checked), and Modbus Type (RTU selected, Ascii unselected). At the bottom of the wizard are buttons for '<< Back', 'Finish', 'Save', 'Cancel', and 'Help'.

### **Modbus Address**

This is the address of the AN6100C. Every system on a common serial bus must be given a unique address. Valid addresses are from 1 to 255.

### **Transmit & Receive functions**

These define the Modbus functions for transmitting and receiving registers.

### **Receive & Transmit Start Address**

This defines the base register address for sending and receiving information.

### ***Parity***

The parity for the serial communications may be selected from :-

- None
- Odd
- Even

The configuration application will always use the parity defined for the AN6100C. If the parity is changed it will not take affect until the current configuration session is complete.

### ***Baud Rate***

The Modbus baud rate may be selected from :-

- 1200
- 2400
- 4800
- 9600
- 19200

The configuration application will always use the baud rate defined for the AN6100C. If the baud rate is changed it will not take affect until the current configuration session is complete.

### ***Modbus Mode***

The Modbus Mode may be selected from :-

- Master
- Slave

A Master unit may issue command functions and a slave unit responds to them. When the AN6100C configuration application is being used the AN6100C will be in slave mode independent of its Mode setting.

### ***Data Type***

The Modbus Data Type may be selected from :-

- AN3135 Point State
- Point
- State

Reference Appendix A for a complete description of these Data Types.

### ***Slave Address***

This is used when the AN-6100C is selected as a Modbus Master. The Slave Address refers to the device that the Master is communicating to. Valid addresses are from 1 to 255.

### ***Transmit Controls***

If this option is selected Silence, Acknowledge and Reset controls will be transmitted and received along with point data.

### ***Modbus Type***

This is a format in which the data is transmitted. Can be set to ASCII or RTU.

## Quick Access

### Toolbar

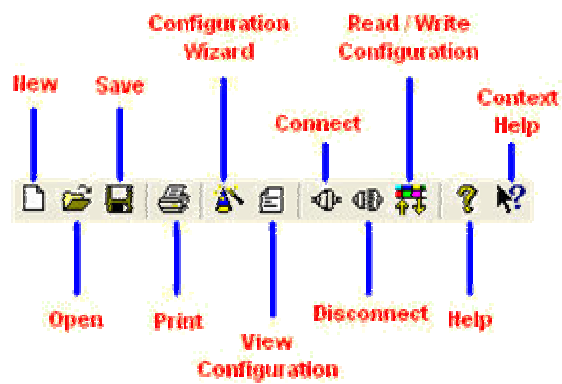

### Hot Keys

Action	Hot Key
New Document	CTRL + N
Open Document	CTRL + O
Save	CTRL + S
Print Configuration	CTRL + P
View Configuration	CTRL + V
Connect	CTRL + C
Disconnect	CTRL + D
Create Duplicate	CTRL + R
Connection Status	CTRL + T
Run Wizard	CTRL + W





# SERVICING

Ensure that the power supply to the unit is switched off before servicing.

## MODULE REMOVAL

### CAUTION

**Note and record the window positions when removed from the chassis so as to ensure that the windows are replaced in their original locations**

**Severe problems/damage could occur to monitored plant/equipment should windows be replaced in incorrect positions causing erroneous indication of alarms**

**Only remove one window assembly at a time to minimise the possible incorrect repositioning of alarm display windows**



# APPENDIX A

## MODBUS DATA FORMATS

The system has the capability of operating with three distinct data formats viz: fault mode, alarm state mode and AN3135 mode. The latter is designed to be compatible with existing AN3100 modbus installations. All these formats are embedded within modbus data registers for transmission and reception.

A selection of Modbus function may be used and these vary depending on the whether the AN6100C is operating as Modbus master or slave.

Function	Description	Data Units	Slave I/O	Mode
3	Read Holding Registers	Words	Output	Master or slave
6	Preset Single Register	Words	Input	Slave only
7	Read Exception Status	Bytes	Output	Slave only
16	Preset Multiple Registers	Words	Input	Master or slave
17	Report Slave ID	Bytes	Output	Slave only

A function value of 03 (Read Holding Registers) is set to read alarm data from the system (in slave configuration). Function values 06 (Preset Single Register) and 16 (Preset Multiple Registers) are set used to write fault and control data. Single and multiple register writes are supported. Exception status responses (function 07) and Slave ID (function 17) are also supported. Exception codes for unrecognized received messages are also included.

The modbus functions are enabled by a software switch and require a key to enable them which is supplied by Ametek. This may be done prior to delivery or retrofitted to installed systems.

## Alarm State Mode

The system can provide data reflecting the alarm state of the system. This mode operates as output only from the system.

The alarm state data is present within a 16 bit register format as shown in the table below. The data is in a nibble format (4 bits per point, 4 points per register) and reflects the already established DMS3000/RTU3000 style format. Note the control transfer is not supported in this mode as the control state of any point is included within the data transferred.

Bit

Point 1, First up, unacknowledged

Point 1, Subsequent up, unacknowledged

Point 1, Acknowledged

Point 1, Fault

The data layout is as shown below.

Word	Bit15-bit12	Bit11-bit8	Bit7-bit4	Bit3-Bit0
1	AP 04	..	..	AP 01
..	..	..	.	..
N	AP N	..	..	AP N-3

## Point Mode

The system can present or accept raw field input point data plus alarm controls. Single and multiple register writes are supported. Data is again presented in a 16 bit register format. The last word of a transfer of input data may optionally contain control data.

The data layout for a sample system configured for point data will be as below.

Word	Bit15	.....	.....	Bit6	Bit5	Bit4	Bit3	Bit2	Bit1	Bit0
1	AP 16			..	..	..	..	..	..	AP 01
..	..			..	..	..	..	..	..	..
N/16	AP N			..	..	..	..	..	..	AP N-15
(N/16) +1							Ack Act	Rst Act	Ack Mtr	Rst Mtr

## AN3135 Mode

The system has the capability of mimicking the existing AN3135 functionality used with the AN3100 type systems. The object is to provide a system that is backwards compatible with the existing AN3135 product and AN3100 systems. The AN3135 mode is restricted to the default Functions of 03 to read alarm data and 06 and 16 being used to write fault and control data. The principal difference between this and the point mode above is that the AN3135 mode is restricted to 64 points.

The data layout for a sample system configured for point data will be as below.

Word	Bit15	.....	.....	Bit6	Bit5	Bit4	Bit3	Bit2	Bit1	Bit0
1	AP 16			..	..	..	..	..	..	AP 01
..	..			..	..	..	..	..	..	..
4	AP 64			..	..	..	..	..	..	AP 49
5							Ack Act	Rst Act	Ack Mtr	Rst Mtr

## Modbus Addresses

Conventional addresses are not included in the configuration and should be input by the user. The input and output functions here are the most common and refer to a system in slave configuration.

Conventional Start address	Data	Input Functions	Output Functions
00000	Output Coils	05,15	01
10000	Discrete Inputs		02
30000	Input Registers		04
40000	Holding (output) Registers	06,16	03
60000	Extended Memory		

## Default Values

Designation	Options	Default	Comments
Modbus Address	0-255	01	
Receive Start Address	0-65535	40000	Raw address entry. User must include standard Modbus address offsets
Transmit Start Address	0-65535	40000	
Modbus Mode	Master/Slave	Slave	Is this system Modbus Master?
Data type	AN3135 Style AN3150/Point/State	Point	An3150 mimic, point or alarm state data.
Baud rate	2400/4800/ 9600/19200	9600	
Parity	Odd/Even/none	None	Parity type
Transmit controls	Yes/No		Send alarm control (ACK, RST) data
Data direction	Input/output	Output	1 bit per point to designate Tx/Rx data
Modbus format	ASCII/RTU	RTU	

# APPENDIX B

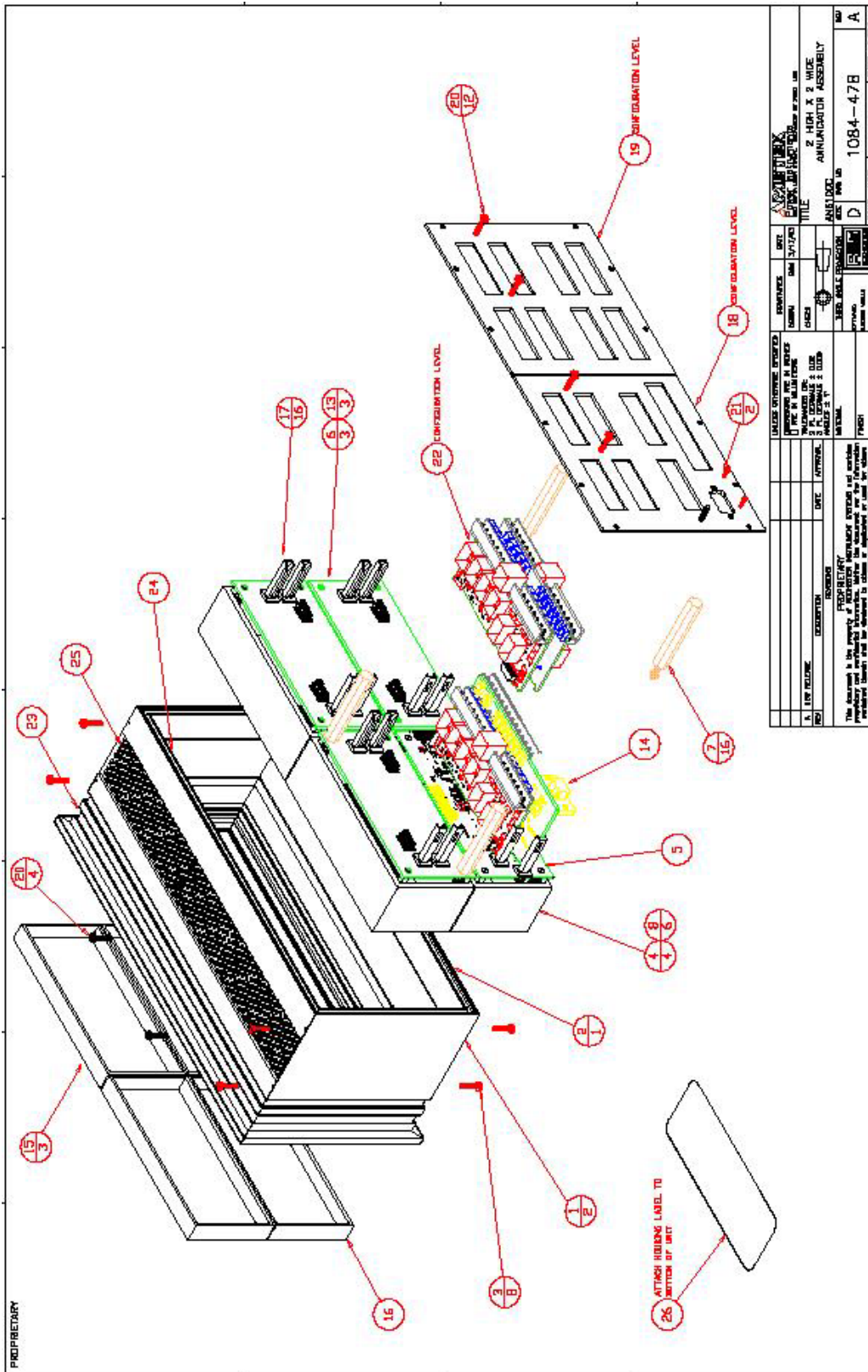

PROPRIETARY

UNLESS OTHERWISE SPECIFIED	REVISEMENTS	DATE	BY	REASON
1. DIMENSIONS	1	11/17/03	WJW	INITIAL RELEASE
2. MATERIALS	2	11/17/03	WJW	INITIAL RELEASE
3. FINISHES	3	11/17/03	WJW	INITIAL RELEASE
4. WEIGHTS	4	11/17/03	WJW	INITIAL RELEASE
5. TOLERANCES	5	11/17/03	WJW	INITIAL RELEASE
6. SURFACE FINISHES	6	11/17/03	WJW	INITIAL RELEASE
7. FINISHES	7	11/17/03	WJW	INITIAL RELEASE
8. WEIGHTS	8	11/17/03	WJW	INITIAL RELEASE
9. FINISHES	9	11/17/03	WJW	INITIAL RELEASE
10. WEIGHTS	10	11/17/03	WJW	INITIAL RELEASE
11. FINISHES	11	11/17/03	WJW	INITIAL RELEASE
12. WEIGHTS	12	11/17/03	WJW	INITIAL RELEASE
13. FINISHES	13	11/17/03	WJW	INITIAL RELEASE
14. WEIGHTS	14	11/17/03	WJW	INITIAL RELEASE
15. FINISHES	15	11/17/03	WJW	INITIAL RELEASE
16. WEIGHTS	16	11/17/03	WJW	INITIAL RELEASE
17. FINISHES	17	11/17/03	WJW	INITIAL RELEASE
18. WEIGHTS	18	11/17/03	WJW	INITIAL RELEASE
19. FINISHES	19	11/17/03	WJW	INITIAL RELEASE
20. WEIGHTS	20	11/17/03	WJW	INITIAL RELEASE
21. FINISHES	21	11/17/03	WJW	INITIAL RELEASE
22. WEIGHTS	22	11/17/03	WJW	INITIAL RELEASE
23. FINISHES	23	11/17/03	WJW	INITIAL RELEASE
24. WEIGHTS	24	11/17/03	WJW	INITIAL RELEASE
25. FINISHES	25	11/17/03	WJW	INITIAL RELEASE
26. WEIGHTS	26	11/17/03	WJW	INITIAL RELEASE

PROPRIETARY

ITEM NUMBER	DESCRIPTION	P/N
1	BEZEL EXT. 2-CELL HIGH	1084-461
2	BEZEL EXT. 8-CELL WIDE	1084-465
3	SCREW 2-56 X 3/8	0627-682
4	CELL MOUNTING	2701-405
5	COMMON SERVICE MODULE PCB	1084-455
6	MAIN MODULE PCB DETAIL	1084-450
7	PLASTIC BUTTON	1084-288
8	JOINING PEG	2701-407
10	MOUNTING BRACKET	2701-409
11	SCREW M4 X 40mm	0900-189
13	IDC CONNECTOR	4130-019
14	CSM I/O PCB ASSEMBLY	1084-457
15	DISPLAY WINDOW ASSEMBLY	1084-499
16	DISPLAY WINDOW ASSM CSM	1084-278
17	CARD GUIDES	4198-040
18	CSM REAR PANEL	CONFIG LEVEL
19	SGM REAR PANEL	CONFIG LEVEL
20	SCREW 4-40 X 3/8	0627-961
21	JACK SCREWS	4195-210
22	SGM PC BOARDS	CONFIG LEVEL
23	PERIMETER BEZEL TOP FRONT	1084-837
24	PERIMETER BEZEL TOP REAR	1084-843
25	PERFORATED VENT	1084-848
26	HOUSING LABEL	1084-293

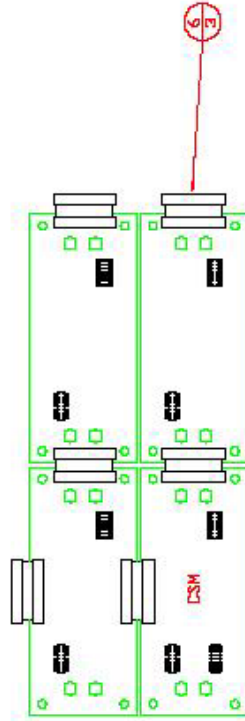

CONTINUE THIS FRONT FOR RIBBON  
CABLE CONNECTORS ON LARGER UNITS.

JACKSON CITY (ORANGE COUNTY) CALIFORNIA 10000 W. 100th AVE. SUITE 100 FORT COLLINS, CO 80526-1000	
TITLE 2 HIGH X 2 WIDE ANNUNCIATOR ASSEMBLY	PART NO. 1084-478
DATE D	REV. A
DRAWN BY D	CHECKED BY A
SCALE 1:1	SHEET 1 OF 3



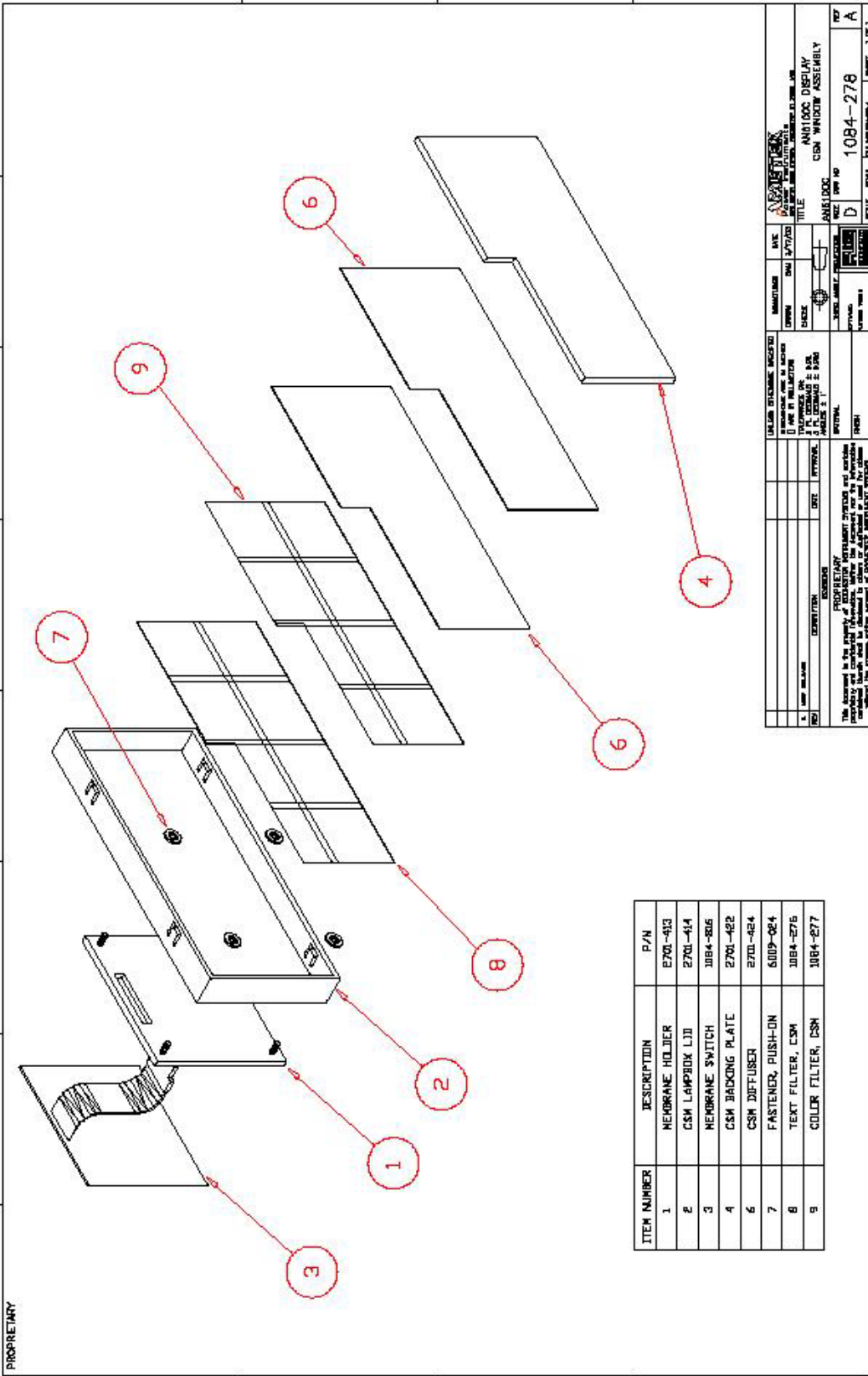

ITEM NUMBER	DESCRIPTION	P/N
1	MEMBRANE HOLDER	2701-413
2	CSM LAMPBOX LID	2701-414
3	MEMBRANE SWITCH	3084-806
4	CSM BACKING PLATE	2701-422
5	CSM DIFFUSER	2701-424
7	FASTENER, PUSH-ON	6109-024
8	TEXT FILTER, CSM	3084-276
9	COLOR FILTER, CSM	3084-277

DATE	1/17/20	DESIGNED BY	AMSD/DC
APPROVED BY		DATE	1/17/20
<input type="checkbox"/> FOR FIELD USE <input type="checkbox"/> FOR TESTING & BURN IN ONLY <input type="checkbox"/> FOR TESTING & BURN IN ONLY		TITLE AN-6100C CSM WINDOW ASSEMBLY	
PART NUMBER 1084-278		REV D	
DRAWN BY AMSD/DC		CHECKED BY AMSD/DC	
DATE 1/17/20		SCALE 1:1	
SHEET NO. 1		TOTAL SHEETS 1	

THIS DOCUMENT IS THE PROPERTY OF ANSYS INCORPORATED. IT IS LOANED TO YOU BY ANSYS INCORPORATED. IT IS NOT TO BE REPRODUCED OR TRANSMITTED IN ANY FORM OR BY ANY MEANS, ELECTRONIC OR MECHANICAL, INCLUDING PHOTOCOPYING, RECORDING, OR BY ANY INFORMATION STORAGE AND RETRIEVAL SYSTEM.

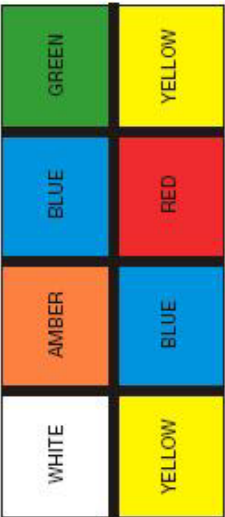
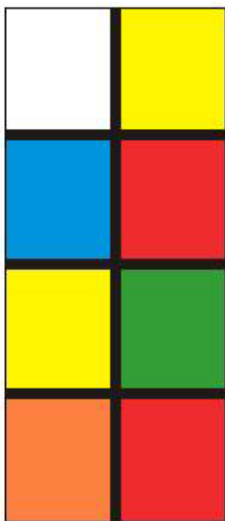

2.138"

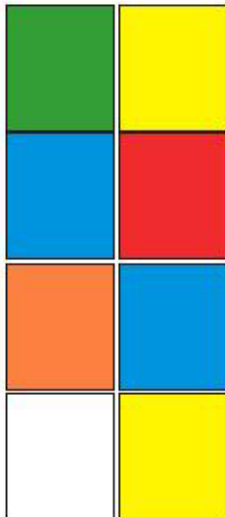
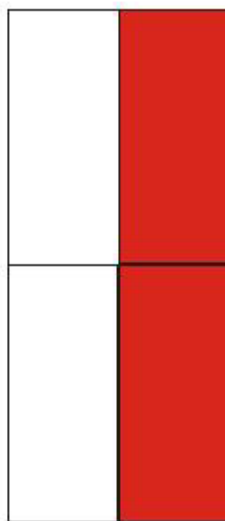
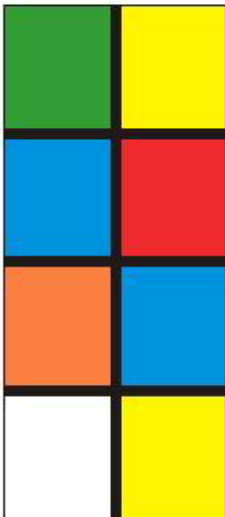
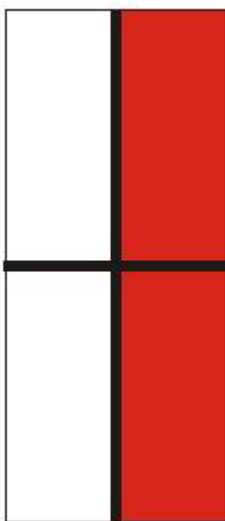

4.956"

Material: HP Color LaserJet  
Transparencies  
C2934A

Power Instruments 2430 - 2nd Floor - 1000 North Main Street - 1st Floor - 1000	
4311 Window East/Color H8er B 1084-274 81	
ROchester EAST COAST	
1000 North Main Street 1st Floor - 1000 1000 North Main Street 1000 North Main Street 1000 North Main Street 1000 North Main Street	
The information on this page is the property of ANEXIA Power Instruments and is not to be used for any other purpose without the express written permission of ANEXIA Power Instruments. All rights reserved.	

PROPRIETARY

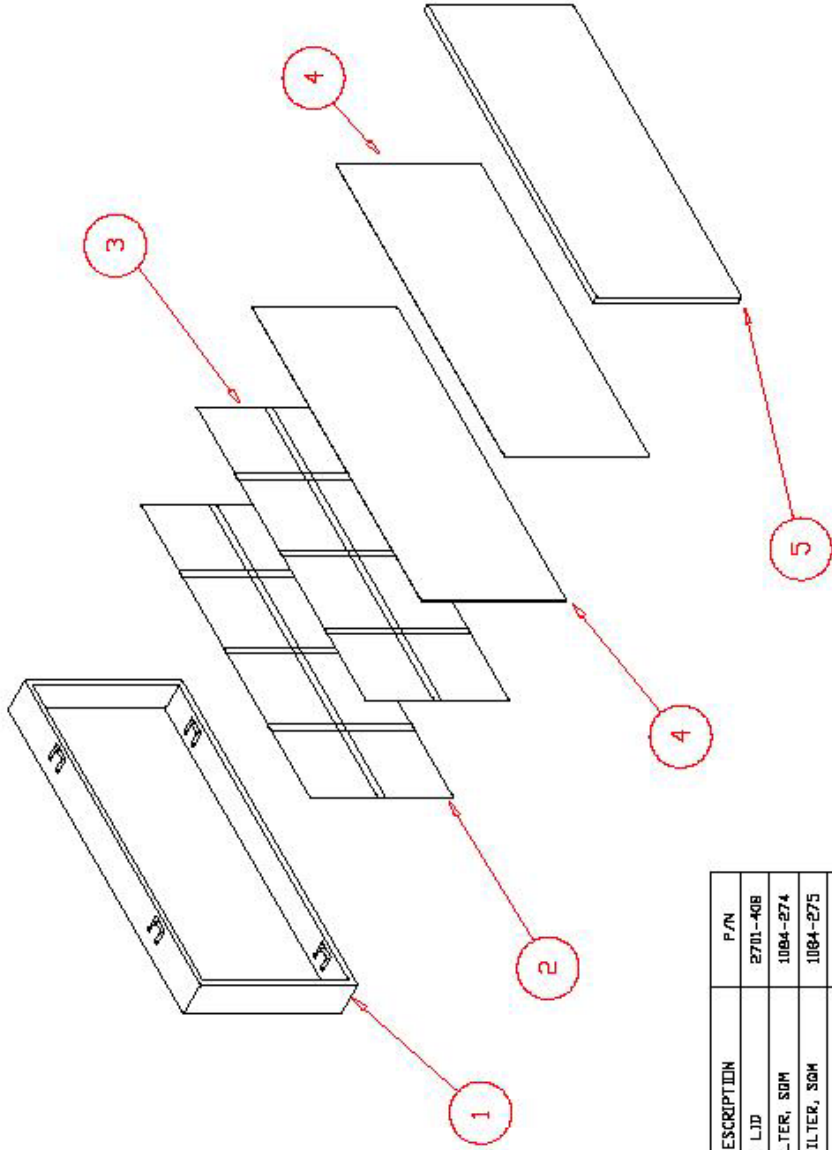

ITEM NUMBER	DESCRIPTION	P/N
1	LAMPBOX LID	2701-408
2	TEXT FILTER, SOM	1084-274
3	COLOR FILTER, SOM	1084-275
4	DIFFUSER	2701-419
5	BACKING PLATE	2701-420

<input type="checkbox"/> REVISIONS <input type="checkbox"/> DATE: 02/11/2003		<input type="checkbox"/> WAREHOUSE STOCKED <input type="checkbox"/> PARTS ARE IN PARTS <input type="checkbox"/> ARE IN INVENTORY <input type="checkbox"/> IS EXHAUSTED + 0.08 <input type="checkbox"/> IS EXHAUSTED + 0.08 <input type="checkbox"/> IS EXHAUSTED + 0.08	
<input type="checkbox"/> NEW RELEASE <input type="checkbox"/> OBSOLETE		<input type="checkbox"/> MATERIAL <input type="checkbox"/> FINISH	
<input type="checkbox"/> REVISIONS <input type="checkbox"/> DATE: 02/11/2003		<input type="checkbox"/> MATERIAL <input type="checkbox"/> FINISH	
<input type="checkbox"/> REVISIONS <input type="checkbox"/> DATE: 02/11/2003		<input type="checkbox"/> MATERIAL <input type="checkbox"/> FINISH	

TITLE: ANNUNCIATOR DISPLAY WINDOW ASSEMBLY	DATE: 02/11/2003
SIZE: D	REV: A
SHEET: 1084-499	SHEET TOTAL: 1084-499



# APPENDIX C

## TELEPHONE / FAX NUMBER LIST

This errata sheet provides an easy-to-use reference for all major departments. Use these numbers for ordering equipment, application assistance, technical support, and scheduling field service

**Please Note:** Your instruction manual may contain other phone and fax numbers; this list will take precedence.

### *MAIN OFFICE*

AMETEK Power Instruments – Rochester  
255 North Union St., Rochester, NY 14605

<b>DEPARTMENT/PRODUCT LINE</b>	<b>TELEPHONE</b>	<b>FAX</b>
MAIN PHONE	585-263-7700	585-262-4777
FIELD SERVICE	800-374-4835	585-238-4945
REPAIRS/RETURNS	888-222-6282	585-238-4945
SALES SUPPORT	800-950-6676	585-454-7805

### *FAR EAST OFFICE*

AMETEK Power Instruments  
271 Bukit Timah Road, #03-09  
Balmoral Plaza, Singapore 259708  
Tel: 65-732-8675  
Fax: 65-732-8676

### *UK OFFICE*

AMETEK Power Instruments  
Unit 20, Ridgeway  
Donibristle Industrial Estate  
Dunfermline, UK  
Tel: 1383-825630  
Fax: 1383-825715

## PROCEDURES FOR FACTORY REPAIR AND RETURN

- A. Obtain a Returned material Authorization (RMA) number by calling AMETEK Repair Sales and giving the following information:
1. **Model** and **Serial Number** of the equipment
  2. Failure Symptom – **Be Specific**
  3. Approximate date of installation
  4. The site name and address of the failed equipment
  5. Complete shipping information for the return of the equipment if other than the operating site
  6. Name and telephone number of person to contact if questions arise.
- B. Enclose the information with the equipment and pack in a commercially accepted shipping container with sufficient packing material to insure that no shipping damage will occur. Mark the outside of the container with the RMA number. Ship to the appropriate location: **Attention:** Repair Department
- AMETEK Power Instruments**  
255 North Union Street  
Rochester, New York 14605 USA  
Tel: (888) 222-6282  
Fax: (585) 238-4945
- C. Your emergency equipment will be tested, repaired and inspected at the factory. Factory turnaround is ten working days or less (excluding shipping time).
- D. For emergency service or repair status information, please contact the AMETEK Repair Sales Engineer at (800) 374-4835.

## WARRANTY

AMETEK warrants equipment of its own manufacture to be free from defects in material and workmanship, under normal conditions of use and service. AMETEK will replace any component found to be defective, upon its return, transportation charges prepaid, within one year of its original purchase. AMETEK will extend the same warranty protection on accessories that is extended to AMETEK by the original manufacturer. AMETEK assumes no responsibility, expressed or implied, beyond its obligation to replace any component involved. Such warranty is in lieu of all other warranties expressed or implied.